

www.rose-plastic.us

rose plastic

General catalog



rose  plastic®
protective packaging pioneers



rose plastic



innovations in plastic packaging



1953 - 2023
70 years



From a “one-man-show” to a global extended family, so to speak

Since the foundation of the company in 1953 by Ernst Rösler, my grandfather, at rose plastic we have consistently focused our activities on the needs and interests of our customers. This was the only way to achieve the growth that transformed our family business from its modest beginnings into the global player with international market significance that we are today.

Under the leadership of my father, Peter Rösler, rose plastic has made a name for itself worldwide as a pioneering provider of robust, well-designed protective plastic packaging. In addition to the entire world of precision tool manufacturers, our customers now include dozens of well-known companies from almost all industries.

However, one thing has remained unchanged – we are still a family business with consistent values and principles. Our primary focus remains your wishes and requirements. We are convinced that satisfied employees and customers are not only the basis for economic success, but also for long-term, mutually beneficial relationships.

Sincerely,

Thiemo Rösler

CEO, rose plastic AG



Everything you need from
a single source – worldwide

We are wherever you need us to be

With around 800 employees at 10 locations around the world, we are also near to our customers. For short distances, reliable logistics, and sustainable business practices.

Plastic packaging from rose plastic optimally protects your products and combines functionality with sales-promoting product presentation. Today, our product range comprises more than 4,000 packaging solutions for a vast range of applications. It includes plastic sleeves, boxes, cassettes, cases, transport and storage systems as well as practical accessories.

CORPORATE HEADQUARTERS

Germany

PRODUCTION LOCATIONS

Germany, USA, China, Brazil, India

SALES LOCATIONS

France, United Kingdom, Spain, Italy, South Korea

SALES PARTNERS

Poland, Turkey, Japan

Doing everything for yourself means you really have your hands full

From the idea to the finished package

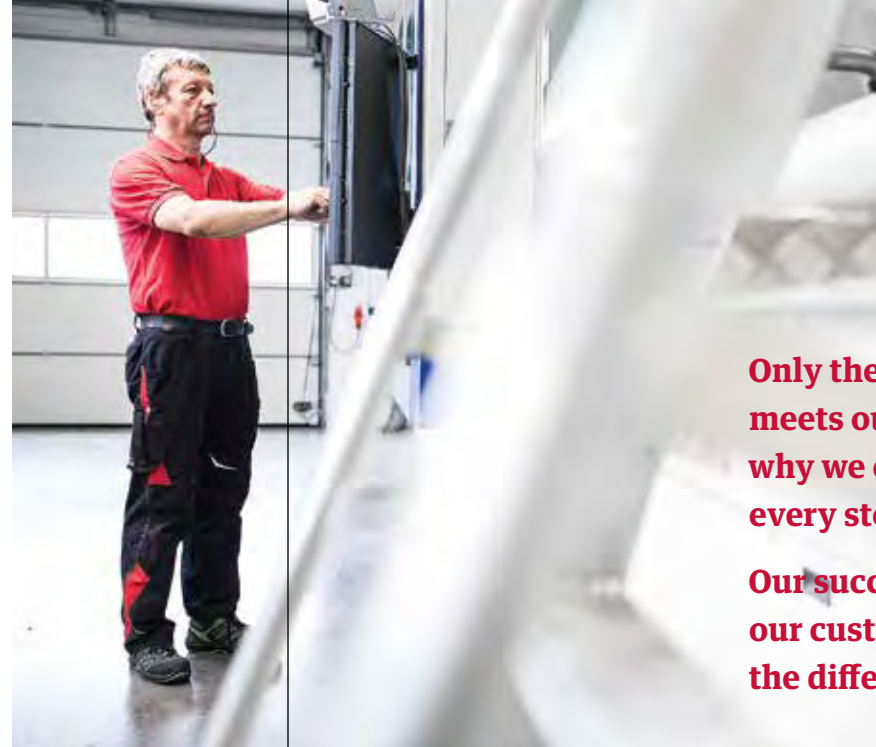

Only the work we do ourselves meets our high standards. That's why we choose to control virtually every step within our business.

Our success has proven us right – our customers feel and appreciate the difference ...

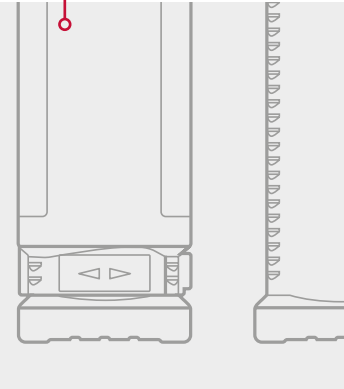

1 The idea

DESIGN AND DEVELOPMENT

A good product is first and foremost based on a good idea that not only takes the customer's wishes into account, but also often exceeds them. The experts in our highly efficient in-house development department take the design and construction of our packaging into their own hands right from the start. They and the proximity to our customers are the reasons for our well-designed, high-quality products.



2 The tool

TOOL SHOP

We produce our packaging using high-precision blow molding and injection molding tools. But who produces our tools? You can probably guess ... Naturally, we also do this ourselves – from the design right through to CNC-supported production. Because decades of experience have taught us the exact requirements for our production tools. Through the years, we have developed and integrated numerous special features that ensure superior process and product quality.

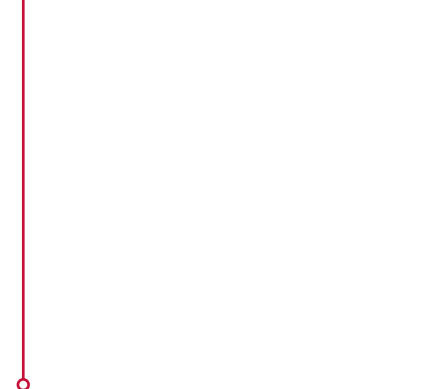

3 The tests

TECHNICAL CENTER

At our in-house technical center we put new tools to the acid test, carry out exhaustive production tests, and give valuable feedback to our development team and tool shop. Our colleagues in this department also perform exacting material tests and trials.



4 The series

PRODUCTION

Our packaging products only go into series production (injection molding and blow molding) once they have been fine-tuned and have successfully passed various tests and inspections. We have also introduced numerous special features into our production process. These allow us to work with higher process reliability in order to achieve higher product quality, while ensuring economical production. The same applies to our sorting department, where the finished products are thoroughly checked, tested and packed for safe transportation.

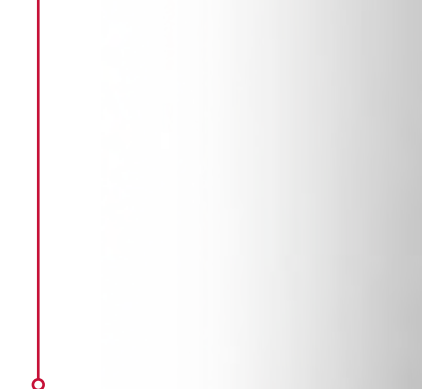

5 The logistics

STORAGE AND SHIPPING

Our warehouses, which are designed for maximum capacity, and our experienced employees ensure that our products are well packed and reach you as soon as possible. Which in turn enables you to quickly deliver well-packaged products to your own customers.



Sustainability. Make the right choice!

More than just a fleeting trend



„rose plastic has been setting new standards with innovative packaging. We also want to be leaders in the area of sustainability.“

THIEMO RÖSLER

1 General information

DID YOU KNOW...

...that plastic packaging consumes comparatively few resources during its production? And that its low weight helps to reduce unnecessary emissions during transport? Studies show that, if plastic packaging were replaced with suitable alternative materials, energy requirements would more than double and CO₂ emissions would virtually triple.

2 Product design

RESOURCE-SAVING

What does packaging need in order to be sustainable? What impact do its production, transport, and use have on the environment? Our designers don't get down to planning until all these questions have been answered. The packaging must be lightweight, yet strong enough to meet all requirements. It must also, if possible, be available in many different sizes to ensure a perfect fit for the products inside. The best example of this is our BlockPack. Furthermore - most of our packaging consists of only one type of plastic. We thus ensure that it can be recycled into high-quality materials at the end of its useful life.

3 Circle Up



RECYCLED MATERIAL

We have proven that plastic packaging and sustainability are not mutually exclusive - by developing our Circle Up packaging made from recycled material. For these products, we rely on the use of recycled material, which is for example made from plastic waste collected by private households. This plastic waste then undergoes professional processing and is transformed back into new, valuable resources - including our Circle Up packaging. "Closed-loop economy" is the magic word here. In other words: Through consistent recycling, the environmental problems associated with plastic waste can be effectively avoided.

4 Organic HDPE



PLANT-POWERED

We have been investigating alternative sources of raw materials for some time now. For example, we have successfully used sugar cane as a renewable raw material. Organic plastics do not consume finite fossil raw materials during their production. Instead, they are derived from renewable resources - and thus also make a significant contribution to reducing CO₂ emissions. These products have the same properties as their counterparts made of conventional plastic, i.e., they are just as strong and durable. We will certainly continue to take a close look at other alternatives in the future.

5 Certification

SIGNED AND SEALED

Since 2011, rose plastic AG has been certified in accordance with the ISO 14001 environmental management system and has signed up to the Bavarian Environmental Pact (Umweltpakt Bayern). In cooperation with our customer, the assembly and fastening experts Würth, we have developed recyclable packaging solutions for cutting tools made from 100% recycled material. These were finalists for the German Sustainability Award in the design category. We have also been awarded with the „Blue Angel“ environmental label by the Ministry of Health in Germany for our Products made from recycled material. After rigorous testing in the categories of material health, material reutilization, renewable energy management, water stewardship and social fairness, our protective packaging used for transport, storage and organization has been endorsed with the Cradle to Cradle® certificate in silver.



SUSTAINABILITY BROCHURE

Interested in learning more about our projects? Want to find out how we live up to our environmental responsibilities at rose plastic? Then we recommend taking a look at our sustainability brochure, which contains clear and concise summaries of all the relevant facts. www.rose-plastic.com

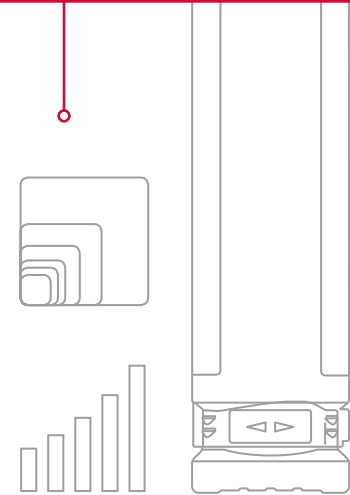

innovations in plastic packaging

PRODUCT RANGE

Tubes



BlockPack	14
BlockPack TabletPunch	16
DIY-Pack for Forstner Drills	18
DIY-Pack rectangular	20
DIY-Pack round	22
TwistPack	24
ScrewPack	26
HexPack	28
HolidayBox	30
MH-Pack	32
MicroBox MB1	34
MicroBox Swing	36
MK-Pack	38
MultiPack	40
PlugPack	42
QuadroPack	44
RectangularPack	46
RoseSet	48
RoundDial-a-Tool	50
ChuckPack	52
SK-Pack CenterLock	54
SlimPack	56

SZ-PlugPack	58
TelePack	60
TopPack	62
TopPack Conical	66
TopPack FoldBack	68
TopPack Wing	70
TopPack XLine	72
TopPack XPress	74
TwistPack Plus	80
VarioBox	82
VarioPack NT	84
VarioPack VP and VPN	86

Boxes



BitPack	90
ConsumerBox	92
FivePack	94
InsertBox / InsertClickBox	96
InsertBox Connect	98
InsertBox HighS	100
InsertSplit Box	102
InsertSplit Box SL	104
MicroBox MB10	106



MicroBox MB50	108
MicroVario Box	109
DIY-Box	110
SplitPack	112
UniBox	114

Cases



MK-Case	122
RoseCase ErgoLine	124
RoseCase ProSecure	126
RoseCase ProTec	128
RoseCase RCB and RCS	132
RoseCassette	134
UniCase	136

Cassettes



FAcassette	140
FBCassette	144
FNKLcassette	146
FNSBcassette	148
GripBox	150
RoseBox	152

Transport & Storage systems



AQRADO®	158
LogisticBox	161
LogisticSystem	162
StorePack	164
SystemBoard	166
SZS-Stands	168

Hangers & Accessories



BlockPack Hanger	172
BlockPack EndCaps	173
DIY-Clips	174
ProtectiveCap	176
ProtectiveEndCaps PSC	178
Foam Inserts	180
Protective Sleeves	184
SDS-Clip	185
ToolHolder	186
TopPackFiveFrame	188

Our plastic packaging tubes

All-rounders and

Our packaging tubes offer optimum product protection as well as top quality sales and transport packaging for a wide variety of products. They stand out thanks to maximum product protection, high functionality, exemplary ergonomics, and appealing designs.



Screw Pack

Round plastic packaging tubes with fixed length and secure screw closure
more on page 26

Block Pack

Square telescopic plastic packaging tubes with TwistLock closure feature and ratchet length adjustment
more on page 14

Twist Pack Plus

More safety. More efficiency. The new generation of TwistPack packaging tubes convince with user-friendly "twist-lock" closure
more on page 80

proven specialists



Holiday Box

Clear plastic tube containers with carry-handle. Ideal packaging solution for retail and consumer products
more on page 30

Top Pack XPress

Plastic packaging tubes with patented shankholding system. Ideal for precision shank tools
more on page 74

Quadro Pack

Square telescopic plastic packaging tubes with ratchet length adjustment
more on page 44



BlockPack

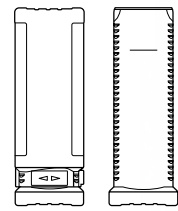

Square telescopic packaging tubes with twist lock closure feature and ratchet length adjustment

- highly secure bayonet-type twist lock closure, requires minimal force in opening and closing the pack
- contoured tube ends and lateral support grooves are integrated together to provide a cushioning effect
- with ratchet length adjustment
- ergonomic product design offers shape stability
- speedy handling
- excellent for stacking and storage
- durable and reusable
- sturdy, oil, and moisture resistant
- optional with hanger or end caps



The ultimate, universal packaging tube with telescopic length adjustment – for maximum product protection



PACKAGING

Outer parts and inner parts are packed separately in individual cartons



MATERIAL

- Polyethylene (PE)
- Polypropylene (PP)
- Polyvinylchloride (PVC)
- Recycled plastic
- Bio plastic



COLORS

- Depending on the material transparent, natural or in various attractive standard colors or two-color



ACCESSORIES

- Hanger (see page 172)
- EndCaps (see page 173)
- ToolHolder (see page 186)
- Foam inserts (see page 180)

USABLE LENGTHS

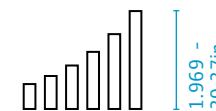

Ø DIAMETER

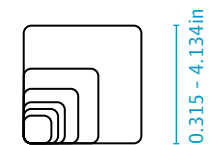

STANDARD COLORS



Product Range

Article	Ø	Usable length	PU	Article	Ø	Usable length	PU
BK 8 050	0.315in	1.969 - 3.15in	3000	BK 32 060	1.26in	2.36 - 3.15in	800
BK 8 080	0.315in	3.15 - 4.724in	3000	BK 32 080	1.26in	3.15 - 4.724in	600
BK 8 120	0.315in	4.724 - 7.874in	1500	BK 32 120	1.26in	4.724 - 7.874in	400
BK 8 200	0.315in	7.874 - 13.78in	2000	BK 32 200	1.26in	7.874 - 13.78in	360
BK 10 050	0.394in	1.969 - 3.15in	2100	BK 32 350	1.26in	13.78 - 24.41in	140
BK 10 080	0.394in	3.15 - 4.724in	2000	BK 35 050	1.378in	1.969 - 2.756in	900
BK 10 120	0.394in	4.724 - 7.874in	1170	BK 35 060	1.378in	2.36 - 3.15in	700
BK 10 200	0.394in	7.874 - 13.78in	1100	BK 35 080	1.378in	3.15 - 4.724in	500
BK 12 050	0.472in	1.969 - 3.15in	2200	BK 35 120	1.378in	4.724 - 7.874in	300
BK 12 080	0.472in	3.15 - 4.724in	1550	BK 35 200	1.378in	7.874 - 13.78in	300
BK 12 120	0.472in	4.724 - 7.874in	800	BK 35 350	1.378in	13.78 - 24.409in	159
BK 12 200	0.472in	7.874 - 13.78in	800	BK 40 080	1.575in	3.15 - 4.724in	450
BK 12 250	0.472in	9.843 - 18.11in	700	BK 40 120	1.575in	4.724 - 7.874in	300
BK 14 050	0.551in	1.969 - 3.15in	1700	BK 40 200	1.575in	7.874 - 13.78in	240
BK 14 080	0.551in	3.15 - 4.724in	1100	BK 40 350	1.575in	13.78 - 24.409in	120
BK 14 120	0.551in	4.724 - 7.874in	800	BK 45 060	1.772in	2.362 - 3.15in	450
BK 14 200	0.551in	7.874 - 13.78in	600	BK 45 080	1.772in	3.15 - 4.724in	350
BK 16 050	0.63in	1.969 - 3.15in	1600	BK 45 120	1.772in	4.724 - 7.874in	275
BK 16 080	0.63in	3.15 - 4.724in	850	BK 45 200	1.772in	7.874 - 13.78in	160
BK 16 120	0.63in	4.724 - 7.874in	1200	BK 45 350	1.772in	13.78 - 24.409in	90
BK 16 200	0.63in	7.874 - 13.78in	1200	BK 55 060	2.165in	2.362 - 3.15in	250
BK 18 050	0.709in	1.969 - 3.15in	1300	BK 55 080	2.165in	3.15 - 4.724in	200
BK 18 080	0.709in	3.15 - 4.724in	850	BK 55 120	2.165in	4.724 - 7.874in	200
BK 18 120	0.709in	4.724 - 7.874in	1050	BK 55 200	2.165in	7.874 - 13.78in	100
BK 18 200	0.709in	7.874 - 13.78in	400	BK 55 350	2.165in	13.78 - 24.409in	70
BK 20 050	0.787in	1.969 - 3.15in	1200	BK 65 080	2.559in	3.15 - 4.724in	210
BK 20 080	0.787in	3.15 - 4.724in	1300	BK 65 120	2.559in	4.724 - 7.874in	120
BK 20 120	0.787in	4.724 - 7.874in	900	BK 65 200	2.559in	7.874 - 13.78in	90
BK 20 200	0.787in	7.874 - 13.78in	800	BK 65 350	2.559in	13.78 - 24.409in	48
BK 20 350	0.787in	13.78 - 24.41in	500	BK 75 080	2.953in	3.15 - 4.724in	168
BK 22 050	0.866in	1.969 - 3.15in	1000	BK 75 120	2.953in	4.724 - 7.874in	96
BK 22 080	0.866in	3.15 - 4.724in	1200	BK 75 200	2.953in	7.874 - 13.78in	58
BK 22 120	0.866in	4.724 - 7.874in	800	BK 85 080	3.346in	3.15 - 4.724in	90
BK 22 200	0.866in	7.874 - 13.78in	600	BK 85 120	3.346in	4.724 - 7.874in	72
BK 24 050	0.945in	1.969 - 3.15in	750	BK 85 200	3.346in	7.874 - 13.78in	48
BK 24 080	0.945in	3.15 - 4.724in	1000	BK 85 350	3.346in	13.78 - 24.409in	30
BK 24 120	0.945in	4.724 - 7.874in	700	BK 85 550	3.346in	21.654 - 39.37in	20
BK 24 200	0.945in	7.874 - 13.78in	550	BK 95 080	3.74in	3.15 - 4.724in	80
BK 26 050	1.024in	1.969 - 2.362in	700	BK 95 120	3.74in	4.724 - 7.874in	60
BK 26 060	1.024in	2.36 - 3.15in	700	BK 95 200	3.74in	7.874 - 13.78in	30
BK 26 080	1.024in	3.15 - 4.724in	850	BK 95 350	3.74in	13.78 - 24.409in	20
BK 26 120	1.024in	4.724 - 7.874in	600	BK 105 080	4.134in	3.15 - 4.724in	80
BK 26 200	1.024in	7.874 - 13.78in	450	BK 105 120	4.134in	4.724 - 7.874in	48
BK 26 350	1.024in	13.78 - 24.41in	288	BK 105 200	4.134in	7.874 - 13.78in	30
BK 32 050	1.26in	1.969 - 2.756in	1200	BK 105 350	4.134in	13.78 - 24.409in	20

Awards





BlockPack TabletPunch

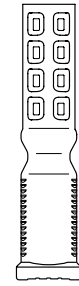

Packaging solution for tableting punches with twist lock closure feature

- the sensitive tip of the tableting punch is suspended for optimum protection
- highly secure bayonet-type twist lock closure, requires minimal force in opening and closing the pack
- contoured tube ends and lateral stiffening grooves provide protection for the punch
- ergonomic product design offers shape stability
- easy handling; durable and reusable
- excellent for stacking and storage
- two sizes accommodate the most common tableting tool designs
- please note that rose plastic BlockPack TabletPunch must not be sold or resold in the UK



The perfect packaging solution for optimal protection of high-quality tableting punches



PACKAGING

Outer parts and inner parts are packed separately in individual cartons



MATERIAL

- Polyethylene (PE)
- Polyvinylchloride (PVC)
- Recycled plastic
- Bio plastic



COLORS

- Depending on the material transparent, natural or in various attractive standard colors or two-color

USABLE LENGTH



Ø DIAMETER

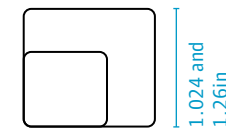

STANDARD COLORS

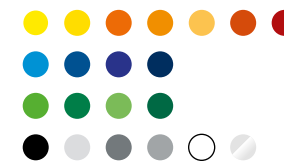

Product Range

Article	Inner diam.	Shank diam.	Usable length fix	PU
BKT 26 140 A+I	1.024in	0.768in	5.512in	600
BKT 32 140 A+I	1.26in	1.024in	5.512in	400

A = outer part; I = inner part

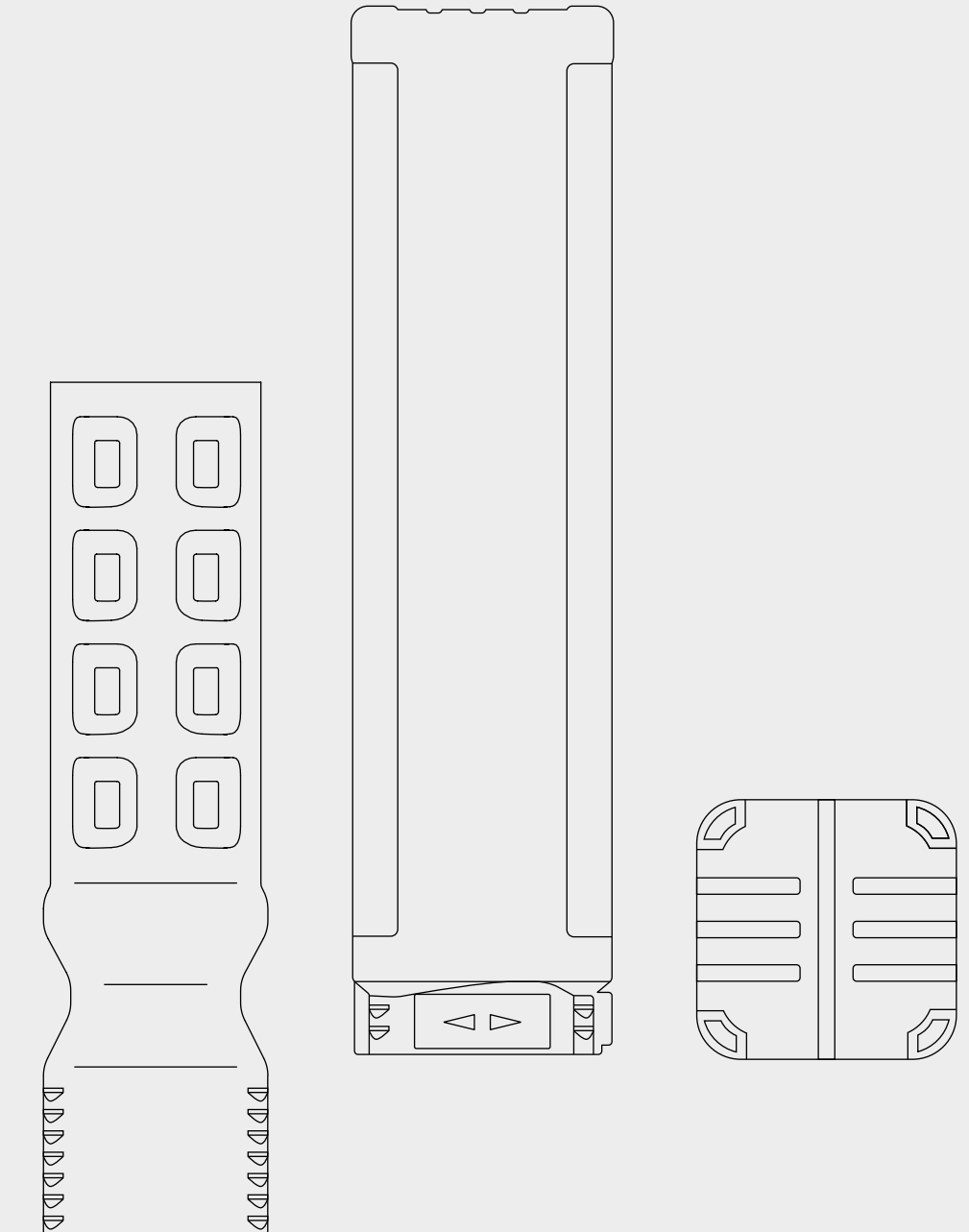

DIY-Pack for Forstner Drills

Plastic packaging and storage tubes for Forstner drills

- ideal for in-store display of Forstner drills
- tube bottom reinforced (cross shaped) for optimum protection
- ideal for product storage
- hanger plugs with euro hole or round hole; euro hanger plug available with or without labeling space

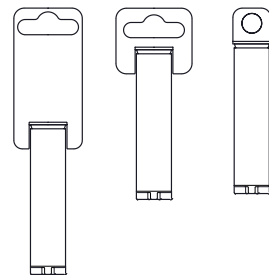

PACKAGING

Tubes and hangers are packed separately in individual cartons



MATERIAL

- Polypropylene (PP)



COLORS

- Tubes in transparent, hanger plugs in various attractive standard colors

USABLE LENGTH



Ø DIAMETER

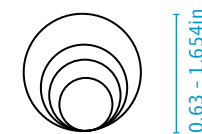

STANDARD COLORS



Product Range

Tubes round

Article	Inner diam.	Inner length	PU
DYH 16 095/2	0.63in	3.74in	1800
DYH 22 095/2	0.866in	3.74in	1100
DYH 35 095/2	1.378in	3.74in	500
DYH 42 095/2	1.654in	3.74in	350

Hangers round

Article	Suitable for	Hanger	Hanger length	Hanger width	PU
DYT 15x18 10/1	DIY-Pack Ø 10	round hole hanger	0.709in	0.591in	12000
DYT 36x74 10/1	DIY-Pack Ø 10	euro hole hanger long	2.913in	1.417in	1500
DYT 40x34 10/1	DIY-Pack Ø 10	euro hole hanger short	1.339in	1.575in	4000
DYT 20x18 16/1	DIY-Pack Ø 16	round hole hanger	0.709in	0.787in	5000
DYT 36x74 16/1	DIY-Pack Ø 16	euro hole hanger long	2.913in	1.417in	2000
DYT 40x34 16/1	DIY-Pack Ø 16	euro hole hanger short	1.339in	1.575in	4000
DYT 26x18 22/1	DIY-Pack Ø 22	round hole hanger	0.709in	1.024in	3000
DYT 36x74 22/1	DIY-Pack Ø 22	euro hole hanger long	2.913in	1.417in	1500
DYT 40x34 22/1	DIY-Pack Ø 22	euro hole hanger short	1.339in	1.575in	3000
DYT 36x61 35/1	DIY-Pack Ø 35	euro hole hanger long	2.402in	1.417in	1000
DYT 39x17 35/1	DIY-Pack Ø 35	round hole hanger	0.669in	1.535in	1500
DYT 40x34 35/1	DIY-Pack Ø 35	euro hole hanger short	1.339in	1.575in	2000
DYT 36x61 42/1	DIY-Pack Ø 42	euro hole hanger long	2.402in	1.417in	900
DYT 40x34 42/1	DIY-Pack Ø 42	euro hole hanger short	1.339in	1.575in	1500
DYT 46x17 42/1	DIY-Pack Ø 42	round hole hanger	0.669in	1.811in	1500

Euro hole hanger long

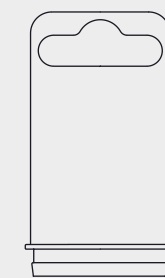

Euro hole hanger short

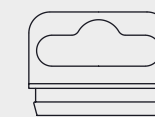

Round hole hanger



The perfect solution to protect, present, and sell Forstner drills and artificial drills more effectively

DIY-Pack rectangular

Rectangular packaging and storage tubes for drills, chisels, sawblades and welding rods

- ideal for in-store product display
- one size label covers entire range
- lends itself to automated packaging
- reinforced tube bottom

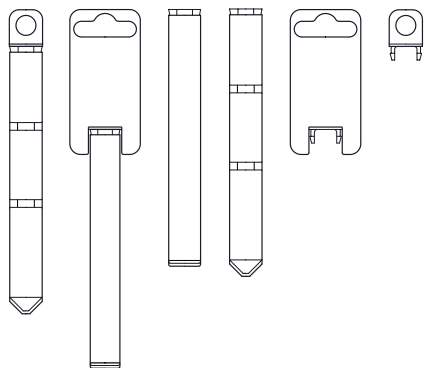

PACKAGING

Tubes and hangers are packed separately in individual cartons



MATERIAL

- Polypropylene (PP)



COLORS

- Tubes in transparent, hanger plugs in various attractive standard colors

USABLE LENGTHS

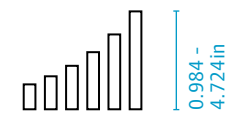

DIMENSION



STANDARD COLORS



Product Range

Tubes rectangular

Article	Version	Description	Inner width	Inner height	Inner length	PU
DYR 7x15 025/1	1	plane version	0.276in	0.591in	0.984in	5000
DYR 7x15 055/3	3	w/ feeder for bits	0.276in	0.591in	2.165in	3000
DYR 7x15 080/1	1	plane version	0.276in	0.591in	3.15in	2200
DYR 7x15 080/2	2	w/ feeder for drills	0.276in	0.591in	3.15in	2200
DYR 7x15 110/1	1	plane version	0.276in	0.591in	4.331in	1500
DYR 7x15 110/2	2	w/ feeder for drills	0.276in	0.591in	4.331in	1500
DYR 7x15 120/1	1	plane version	0.276in	0.591in	4.724in	1300
DYR 7x15 120/2	2	w/ feeder for drills	0.276in	0.591in	4.724in	1300

Hangers rectangular

Article	Hanger	Hanger length	Hanger width	PU
DYE 17x18 7x15/1	round hole hanger	0.709in	0.669in	5000
DYE 36x74 7x15/1	euro hole hanger long	2.913in	1.417in	3000

Euro hole hanger long

Round hole hanger

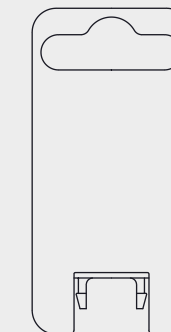

Effective product protection, high-impact presentation of goods: This versatile DIY packaging is the highlight of any point of sale

DIY-Pack round

Round packaging and storage tubes for drills, chisels and welding rods

- ideal for in-store product display
- one size label covers entire range
- suitable for automated packaging
- reinforced tube bottom

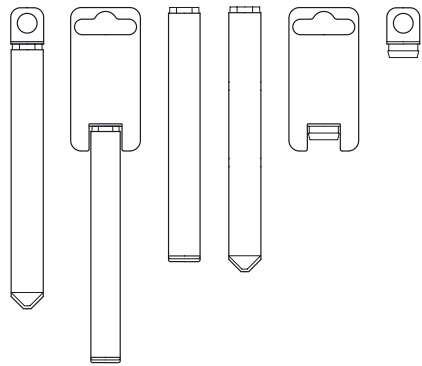

PACKAGING

Tubes and hangers are packed separately in individual cartons



MATERIAL

- Polypropylene (PP)



COLORS

- Tubes in transparent, hanger plugs in various attractive standard colors

USABLE LENGTHS

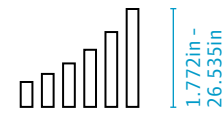

Ø DIAMETER

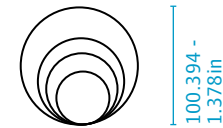

STANDARD COLORS



Product Range

Tubes round

Article	Version	Inner diam.	Length	PU	Article	Version	Inner diam.	Length	PU
DYH 10 085	1/3	0.394in	3.504in	2000	DYH 16 605	1/3	0.63in	23.898in	574
DYH 10 110	1/3	0.394in	4.488in	1700	DYH 16 640	1/3	0.63in	25.276in	578
DYH 10 125	1/3	0.394in	5.079in	2400	DYH 22 160	1/3	0.866in	6.378in	600
DYH 10 165	1/3	0.394in	6.654in	1700	DYH 22 200	1/3	0.866in	8.032in	750
DYH 10 220	1/3	0.394in	8.819in	1300	DYH 22 250	1/3	0.866in	10in	600
DYH 10 245	1/3	0.394in	9.646in	2300	DYH 22 300	1/3	0.866in	11.969in	530
DYH 10 270	1/3	0.394in	10.787in	2300	DYH 22 320	1/3	0.866in	12.756in	517
DYH 10 320	1/3	0.394in	12.756in	1000	DYH 22 355	1/3	0.866in	13.976in	470
DYH 16 045	1/3	0.63in	1.772in	2000	DYH 22 405	1	0.866in	16.102in	400
DYH 16 138	1/3	0.63in	5.433in	1100	DYH 22 440	1	0.866in	17.48in	350
DYH 16 155	1/3	0.63in	6.181in	900	DYH 22 470	1	0.866in	18.661in	350
DYH 16 160	1/3	0.63in	6.378in	1600	DYH 22 605	1	0.866in	23.976in	310
DYH 16 205	1/3	0.63in	8.15in	1300	DYH 22 640	1	0.866in	25.354in	440
DYH 16 255	1/3	0.63in	10.118in	1100	DYH 35 160	1/3	1.378in	6.378in	420
DYH 16 265	1/3	0.63in	10.512in	1100	DYH 35 250	1/3	1.378in	10in	280
DYH 16 305	1/3	0.63in	12.087in	920	DYH 35 320	1/3	1.378in	12.756in	200
DYH 16 320	1/3	0.63in	12.677in	900	DYH 35 355	3/3	1.378in	13.976in	200
DYH 16 410	1/3	0.63in	16.22in	680	DYH 35 470	1/3	1.378in	18.661in	180
DYH 16 445	1/3	0.63in	17.598in	630	DYH 35 605	1/3	1.378in	23.976in	153
DYH 16 475	1/3	0.63in	18.78in	610	DYH 35 670	1/3	1.378in	26.535in	165
DYH 16 510	1/3	0.63in	20.157in	525					

Version 1 = w/ tapered bottom; Version 3 = w/ flat bottom

DIY-Pack Tubes bulk

Article	Inner diam.	Inner length	Suitable for HSS drill-Ø	Drill packing qty. (pcs.)	PU
DYH 10 060/3	0.394in	2.362in	0 - 0.098in	10	1800
DYH 16 078/3	0.63in	3.071in	0.118 - 0.165in	10	2400
DYH 22 098/3	0.866in	3.858in	0.169 - 0.236in	10	1200
DYH 35 122/3	1.378in	4.803in	0.24 - 0.335in	10	400
DYH 35 156/3	1.378in	6.142in	0.413 - 0.512in	5	218
DYH 42 138/3	1.654in	5.433in	0.339 - 0.394in	10	250

Hangers round

Article	Suitable for	Hanger	Hanger length	Hanger width	PU
DYT 15x18 10/1	DIY-Pack Ø 10	round hole hanger	0.709in	0.591in	12000
DYT 36x74 10/1	DIY-Pack Ø 10	euro hole hanger long	2.913in	1.417in	1500
DYT 40x34 10/1	DIY-Pack Ø 10	euro hole hanger short	1.339in	1.575in	4000
DYT 20x18 16/1	DIY-Pack Ø 16	round hole hanger	0.709in	0.787in	5000
DYT 36x74 16/1	DIY-Pack Ø 16	euro hole hanger long	2.913in	1.417in	2000
DYT 40x34 16/1	DIY-Pack Ø 16	euro hole hanger short	1.339in	1.575in	4000
DYT 26x18 22/1	DIY-Pack Ø 22	round hole hanger	0.709in	1.024in	3000
DYT 36x74 22/1	DIY-Pack Ø 22	euro hole hanger long	2.913in	1.417in	1500
DYT 40x34 22/1	DIY-Pack Ø 22	euro hole hanger short	1.339in	1.575in	3000
DYT 36x61 35/1	DIY-Pack Ø 35	euro hole hanger long	2.402in	1.417in	1000
DYT 39x17 35/1	DIY-Pack Ø 35	round hole hanger	0.669in	1.535in	1500
DYT 40x34 35/1	DIY-Pack Ø 35	euro hole hanger short	1.339in	1.575in	2000
DYT 36x61 42/1	DIY-Pack Ø 42	euro hole hanger long	2.402in	1.417in	900
DYT 40x34 42/1	DIY-Pack Ø 42	euro hole hanger short	1.339in	1.575in	1500
DYT 46x17 42/1	DIY-Pack Ø 42	round hole hanger	0.669in	1.811in	1500



The perfect packaging for optimum protection and effective presentation of your product



TwistPack

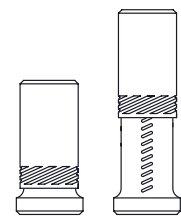

Round telescopic plastic packaging tubes with twist lock mechanism and roll-away protection

- twist lock mechanism holds contents securely in place
- infinitely variable telescopic length adjustment
- hexagon tube bottom prevents rolling
- durable and reusable
- rigid, humidity and oil resistant



As one of the world's best-selling packaging tubes, the TwistPack excels thanks to practical features and almost limitless applications



PACKAGING

Outer parts and inner parts are packed separately in individual cartons; DP 65 350, DP 80 and DP 105 outer parts and inner parts are packed assembled



MATERIAL

- Polyethylene (PE)
- Polypropylene (PP)
- Polyvinylchloride (PVC)
- Recycled plastic
- Bio plastic



COLORS

- Depending on the material transparent, natural or in various attractive standard colors or two-color



ACCESSORIES

- With hanger on request
- Foam Inserts (see page 180)

USABLE LENGTHS

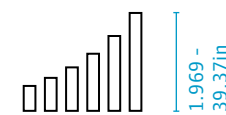

Ø DIAMETER

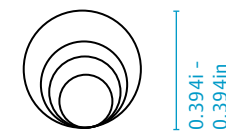

STANDARD COLORS



Product Range

Article	Inner diam.	Usable length	PU	Article	Inner diam.	Usable length	PU
DP 10 050	0.394in	1.969 - 2.756in	2100	DP 35 080	1.378in	3.15 - 4.724in	600
DP 10 080	0.394in	3.15 - 4.724in	2000	DP 35 120	1.378in	4.724 - 7.874in	400
DP 10 120	0.394in	4.724 - 7.874in	2100	DP 35 200	1.378in	7.874 - 13.78in	310
DP 13 050	0.512in	1.969 - 2.756in	2200	DP 35 350	1.378in	13.78 - 24.409in	180
DP 13 080	0.512in	3.15 - 4.724in	1300	DP 40 050	1.575in	1.969 - 2.362in	350
DP 13 120	0.512in	4.724 - 7.874in	1600	DP 40 060	1.575in	2.362 - 3.15in	350
DP 13 200	0.512in	7.874 - 13.78in	1500	DP 40 080	1.575in	3.15 - 4.724in	500
DP 16 050	0.63in	1.969 - 2.756in	1700	DP 40 120	1.575in	4.724 - 7.874in	300
DP 16 080	0.63in	3.15 - 4.724in	1000	DP 40 200	1.575in	7.874 - 13.78in	250
DP 16 120	0.63in	4.724 - 7.874in	1200	DP 40 250	1.575in	9.843 - 15.748in	210
DP 16 200	0.63in	7.874 - 13.78in	1000	DP 40 350	1.575in	13.78 - 24.409in	150
DP 16 350	0.63in	13.78 - 24.409in	600	DP 45 050	1.772in	1.969 - 2.362in	350
DP 16 410	0.63in	16.142 - 30.315in	500	DP 45 060	1.772in	2.362 - 3.15in	600
DP 20 050	0.787in	1.969 - 2.756in	1500	DP 45 080	1.772in	3.15 - 4.724in	400
DP 20 080	0.787in	3.15 - 4.724in	1700	DP 45 120	1.772in	4.724 - 7.874in	250
DP 20 120	0.787in	4.724 - 7.874in	1000	DP 45 200	1.772in	7.874 - 13.78in	200
DP 20 200	0.787in	7.874 - 13.78in	900	DP 45 350	1.772in	13.78 - 24.409in	115
DP 22 050	0.866in	1.969 - 2.362in	1100	DP 50 050	1.969in	1.969 - 2.362in	600
DP 22 080	0.866in	3.15 - 4.724in	1400	DP 50 060	1.969in	2.362 - 3.15in	500
DP 22 120	0.866in	4.724 - 7.874in	850	DP 50 080	1.969in	3.15 - 4.724in	330
DP 22 200	0.866in	7.874 - 13.78in	700	DP 50 120	1.969in	4.724 - 7.874in	220
DP 22 350	0.866in	13.78 - 24.409in	390	DP 50 200	1.969in	7.874 - 13.78in	150
DP 22 410	0.866in	16.142 - 30.315in	300	DP 50 350	1.969in	13.78 - 24.409in	95
DP 24 050	0.945in	1.969 - 2.362in	900	DP 55 050	2.165in	1.969 - 2.362in	500
DP 24 080	0.945in	3.15 - 4.724in	1100	DP 55 060	2.165in	2.362 - 3.15in	400
DP 24 120	0.945in	4.724 - 7.874in	750	DP 55 080	2.165in	3.15 - 4.724in	300
DP 24 200	0.945in	7.874 - 13.78in	600	DP 55 120	2.165in	4.724 - 7.874in	190
DP 26 050	1.024in	1.969 - 2.362in	800	DP 55 200	2.165in	7.874 - 13.78in	135
DP 26 080	1.024in	3.15 - 4.724in	1000	DP 55 350	2.165in	13.78 - 24.409in	70
DP 26 120	1.024in	4.724 - 7.874in	600	DP 65 050	2.559in	1.969 - 2.362in	350
DP 26 200	1.024in	7.874 - 13.78in	450	DP 65 060	2.559in	2.362 - 3.15in	300
DP 26 250	1.024in	9.843 - 15.748in	420	DP 65 080	2.559in	3.15 - 4.724in	220
DP 26 350	1.024in	13.78 - 24.409in	280	DP 65 120	2.559in	4.724 - 7.874in	150
DP 26 410	1.024in	16.142 - 30.315in	240	DP 65 200	2.559in	7.874 - 13.78in	96
DP 28 050	1.102in	1.969 - 2.362in	800	DP 65 350	2.559in	13.78 - 24.409in	46
DP 28 080	1.102in	3.15 - 4.724in	950	DP 80 060	3.346in	2.362 - 3.15in	100
DP 28 120	1.102in	4.724 - 7.874in	600	DP 80 080	3.346in	3.15 - 3.937in	108
DP 28 200	1.102in	7.874 - 13.78in	450	DP 80 120	3.346in	4.724 - 7.087in	72
DP 30 050	1.181in	1.969 - 2.362in	700	DP 80 200	3.346in	7.874 - 13.78in	50
DP 30 080	1.181in	3.15 - 4.724in	800	DP 80 350	3.346in	13.78 - 21.654in	18
DP 30 120	1.181in	4.724 - 7.874in	500	DP 80 550	3.346in	21.654 - 39.37in	18
DP 30 200	1.181in	7.874 - 13.78in	400	DP 105 080	4.134in	3.15 - 3.937in	72
DP 30 350	1.181in	13.78 - 24.409in	230	DP 105 120	4.134in	4.724 - 7.087in	52
DP 30 410	1.181in	16.142 - 30.315in	200	DP 105 200	4.134in	7.874 - 13.78in	30
DP 35 050	1.378in	1.969 - 2.362in	500				
DP 35 060	1.378in	2.362 - 3.15in	900				



ScrewPack

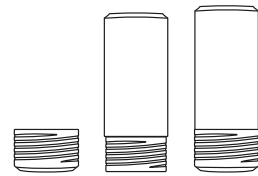

Round plastic packaging tubes with fixed length and secure screw closure

- length is produced to customer requirements
- thread is positioned to customer requirements
- durable and reusable
- sturdy, oil, and moisture resistant



Are you looking for a solid, economical, and versatile packaging tube? You've just found it ...



PACKAGING

Outer parts and inner parts are packed separately in individual cartons



MATERIAL

- Polyethylene (PE)
- Polypropylene (PP)
- Polyvinylchloride (PVC)
- Recycled plastic
- Bio plastic



COLORS

- Depending on the material transparent, natural or in various attractive standard colors or two-color



ACCESSORIES

- With hanger on request
- Foam Inserts (see page 180)

USABLE LENGTHS

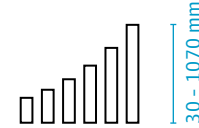

Ø DIAMETER

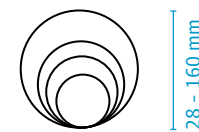

STANDARD COLORS



Product Range

ScrewPack Tubes

Article	Inner diam.	Length outer part min.- max.	Length inner part min.- max.	Total usable length
GP 25	1.102in	0.197-15.236in	0,197-15,236in	31,260in
GP 35	1.457in	0.197-15.236in	0,197-15,236in	31,260in
GP 40	1.614in	0.197-14.173in	0,197-14,173in	29,528in
GP 45	1.811in	0.197-26.969in	0,197-26,969in	55,118in
GP 55	2.205in	0.197-21.457in	0,197-21,457in	40,157in
GP 65	2.598in	0.197-18.898in	0,197-18,898in	39,370in
GP 75	2.992in	0.197-18.898in	0,197-18,898in	39,567in
GP 80	3.11in	0.197-19.291in	0,197-19,291in	40,551in
GP 85	3.346in	1.378in	1,378in	3,543in
GP 90	3.583in	0.197-17.165in	0,197-17,165in	36,260in
GP 100	3.858in	0.197-19.291in	0,197-19,291in	40,551in
GP 105	4.213in	0.197-19.291in	0,197-19,291in	40,551in
GP 125	4.921in	0.394-20.669in	0,394-20,669in	43,701in
GP 160	6.299in	1.181-19.488in	1,181-19,488in	42,126in

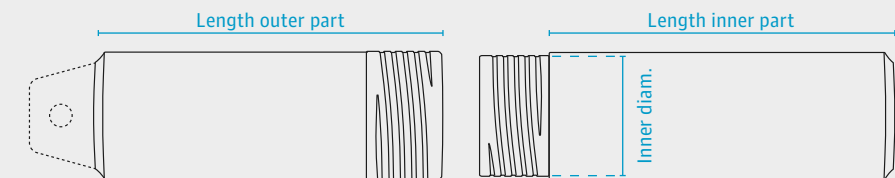

ScrewPack Postal Tubes

Article	Format	Inner diam.	Inner length	Weight (g/psc.)	PU	Article	Format	Inner diam.	Inner length	Weight (g/psc.)	PU
GP 45 220 K	DIN A4	1.811in	8.661in	32	170	GP 45 620 K	DIN A1	1.811in	24.409in	80	58
GP 55 220 K	DIN A4	2.205in	8.661in	40	110	GP 55 620 K	DIN A1	2.205in	24.409in	100	40
GP 65 220 K	DIN A4	2.598in	8.661in	51	82	GP 65 620 K	DIN A1	2.598in	24.409in	132	28
GP 80 220 K	DIN A4	3.11in	8.661in	75	56	GP 80 620 K	DIN A1	3.11in	24.409in	162	20
GP 100 220 K	DIN A4	3.858in	8.661in	108	36	GP 100 620 K	DIN A1	3.858in	24.409in	268	11
GP 45 320 K	DIN A3	1.811in	12.598in	50	121	GP 65 880 K	DIN A0	2.598in	34.646in	185	20
GP 55 320 K	DIN A3	2.205in	12.598in	53	81	GP 80 880 K	DIN A0	3.11in	34.646in	215	14
GP 65 320 K	DIN A3	2.598in	12.598in	80	56	GP 100 880 K	DIN A0	3.858in	34.646in	330	9
GP 80 320 K	DIN A3	3.11in	12.598in	108	40	GP 45 1000 K	*	1.811in	39.37in	124	20
GP 100 320 K	DIN A3	3.858in	12.598in	145	24	GP 55 1120 K	*	2.205in	44.095in	210	14
GP 45 440 K	DIN A2	1.811in	17.323in	58	85	GP 65 800 K	*	2.598in	31.496in	162	9
GP 55 440 K	DIN A2	2.205in	17.323in	72	56	GP 80 800 K	*	3.11in	31.496in	212	70
GP 65 440 K	DIN A2	2.598in	17.323in	110	40	GP 100 800 K	*	3.858in	31.496in	340	45
GP 80 440 K	DIN A2	3.11in	17.323in	136	28						
GP 100 440 K	DIN A2	3.858in	17.323in	184	18						

*Special length

ScrewPack SetPack

Article	Innerdiameter	Usable length fix	PU
GP 65 080 S	2.598in	3.543in	150
GP 65 100 S	2.598in	4.331in	150
GP 65 110 S	2.598in	4.724in	150



HexPack

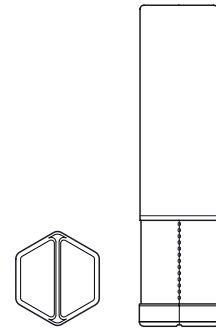

Hexagonal telescopic plastic packaging tubes with ratchet length adjustment. Ideal for drills, milling cutters, shank tools, tool holders and tool bits

- infinitely variable telescopic length adjustment
- speedy efficient packaging
- speedy handling
- excellent for stacking and storage
- durable and reusable
- sturdy, oil, and moisture resistant



The practical packaging tube with a honeycomb design offers excellent product protection and easy telescopic length adjustment



PACKAGING

Outer parts and inner parts are packed separately in individual cartons



MATERIAL

- Polyethylene (PE)
- Polyvinylchloride (PVC)
- Recycled plastic
- Bio plastic



COLORS

- Depending on the material transparent, natural or in various attractive standard colors or two-color



ACCESSORIES

- With hanger on request

USABLE LENGTHS

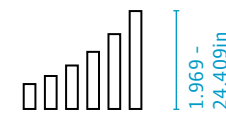

Ø DIAMETER

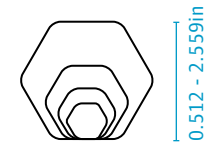

STANDARD COLORS



Product Range

Article	Inner diameter	Usable length adjustable	PU
SW 13 050	0.512in	1.969 - 3.15in	2500
SW 13 080	0.512in	3.15 - 4.724in	2000
SW 13 120	0.512in	4.724 - 7.874in	1700
SW 16 050	0.63in	1.969 - 3.15in	1700
SW 16 080	0.63in	3.15 - 4.724in	1000
SW 16 120	0.63in	4.724 - 7.874in	1000
SW 16 200	0.63in	7.874 - 13.78in	2000
SW 16 350	0.63in	13.78 - 24.409in	700
SW 20 050	0.787in	1.969 - 3.15in	1000
SW 20 080	0.787in	3.15 - 4.724in	1400
SW 20 120	0.787in	4.724 - 7.874in	1000
SW 20 200	0.787in	7.874 - 13.78in	760
SW 20 350	0.787in	13.78 - 24.409in	500
SW 26 060	1.024in	2.362 - 3.15in	1300
SW 26 080	1.024in	3.15 - 4.724in	1000
SW 26 120	1.024in	4.724 - 7.874in	550
SW 26 200	1.024in	7.874 - 13.779in	580
SW 26 350	1.024in	13.78 - 24.409in	250
SW 32 060	1.26in	2.362 - 3.15in	900
SW 32 080	1.26in	3.15 - 4.724in	650
SW 32 120	1.26in	4.724 - 7.874in	400
SW 32 200	1.26in	7.874 - 13.78in	350
SW 32 350	1.26in	13.78 - 24.409in	220
SW 38 060	1.496in	2.362 - 3.15in	650
SW 38 080	1.496in	3.15 - 4.724in	500
SW 38 120	1.496in	4.724 - 7.874in	300
SW 38 200	1.496in	7.874 - 13.78in	270
SW 38 350	1.496in	13.78 - 24.409in	150
SW 45 060	1.772in	2.362 - 3.15in	400
SW 45 080	1.772in	3.15 - 4.724in	300
SW 45 120	1.772in	4.724 - 7.874in	220
SW 45 200	1.772in	7.874 - 13.78in	186
SW 45 350	1.772in	13.78 - 24.409in	106
SW 55 060	2.165in	2.362 - 3.15in	270
SW 55 080	2.165in	3.15 - 4.724in	240
SW 55 120	2.165in	4.724 - 7.874in	220
SW 55 200	2.165in	7.874 - 13.78in	134
SW 55 350	2.165in	13.78 - 24.409in	64
SW 65 080	2.559in	3.15 - 4.724in	180
SW 65 120	2.559in	4.724 - 7.874in	155
SW 65 200	2.559in	7.874 - 13.78in	84

Holiday Box

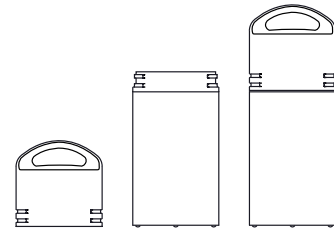

Clear plastic tube containers with carry-handle. Ideal packaging solution for retail and consumer products

- highly transparent material combined with short perimeter thread provides perfect product display
- practical closure mechanism: simple, quick and secure
- variable inner length allows packaging to be sized exactly to the product
- universal application
- fixed length outers with handy, attractively shaped carry-handle
- numerous secondary uses



This packaging tube is a true jack-of-all-trades: The highly transparent PVC makes it ideal as sales packaging as well as a useful tool to store anything you can think of



PACKAGING

Outer parts and inner parts are packed separately in individual cartons



MATERIAL

- Polyvinylchloride (PVC)



COLORS

- PVC clear or in various attractive standard colors

USABLE LENGTHS

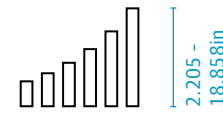

Ø DIAMETER

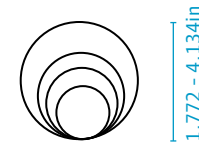

STANDARD COLORS



Product Range

Article	Inner diam.	Usable length	PU	Article	Inner diam.	Usable length	PU
HB 45 025/2	1.772in	2.205in	1000	HB 65 225/2	2.559in	10.63in	1000
HB 45 050/2	1.772in	3.189in	1000	HB 65 250/2	2.559in	11.614in	1000
HB 45 075/2	1.772in	4.173in	1000	HB 65 275/2	2.559in	12.598in	1000
HB 45 100/2	1.772in	5.157in	1000	HB 65 300/2	2.559in	13.583in	1000
HB 45 125/2	1.772in	6.142in	1000	HB 65 325/2	2.559in	14.567in	1000
HB 45 150/2	1.772in	7.126in	1000	HB 65 350/2	2.559in	15.551in	1000
HB 45 175/2	1.772in	8.11in	1000	HB 65 375/2	2.559in	16.535in	1000
HB 45 200/2	1.772in	9.094in	1000	HB 65 400/2	2.559in	17.52in	1000
HB 45 225/2	1.772in	10.079in	1000	HB 65 425/2	2.559in	18.504in	1000
HB 45 250/2	1.772in	11.063in	1000	HB 65 450/2	2.559in	19.488in	1000
HB 45 275/2	1.772in	12.047in	1000	HB 85 040/2	3.346in	3.701in	1000
HB 45 300/2	1.772in	13.032in	1000	HB 85 050/2	3.346in	4.094in	1000
HB 45 325/2	1.772in	14.016in	1000	HB 85 075/2	3.346in	5.079in	1000
HB 45 375/2	1.772in	15.984in	1000	HB 85 100/2	3.346in	6.063in	1000
HB 45 350/2	1.772in	15in	1000	HB 85 125/2	3.346in	7.047in	1000
HB 45 400/2	1.772in	16.969in	1000	HB 85 150/2	3.346in	8.032in	1000
HB 45 425/2	1.772in	17.953in	1000	HB 85 175/2	3.346in	9.016in	1000
HB 45 450/2	1.772in	18.937in	1000	HB 85 225/2	3.346in	10.984in	1000
HB 45 466/2	1.772in	19.567in	1000	HB 85 200/2	3.346in	10in	1000
HB 55 030/2	2.165in	2.677in	1000	HB 85 250/2	3.346in	11.969in	1000
HB 55 050/2	2.165in	3.465in	1000	HB 85 275/2	3.346in	12.953in	1000
HB 55 075/2	2.165in	4.449in	1000	HB 85 300/2	3.346in	13.937in	1000
HB 55 100/2	2.165in	5.433in	1000	HB 85 325/2	3.346in	14.921in	1000
HB 55 125/2	2.165in	6.417in	1000	HB 85 350/2	3.346in	15.906in	1000
HB 55 150/2	2.165in	7.402in	1000	HB 85 375/2	3.346in	16.89in	1000
HB 55 175/2	2.165in	8.386in	1000	HB 85 400/2	3.346in	17.874in	1000
HB 55 200/2	2.165in	9.37in	1000	HB 85 425/2	3.346in	18.858in	1000
HB 55 225/2	2.165in	10.354in	1000	HB 85 440/2	3.346in	19.449in	1000
HB 55 250/2	2.165in	11.339in	1000	HB 105 050/2	4.134in	4.449in	1000
HB 55 275/2	2.165in	12.323in	1000	HB 105 075/2	4.134in	5.433in	1000
HB 55 300/2	2.165in	13.307in	1000	HB 105 100/2	4.134in	6.417in	1000
HB 55 325/2	2.165in	14.291in	1000	HB 105 125/2	4.134in	7.402in	1000
HB 55 350/2	2.165in	15.276in	1000	HB 105 150/2	4.134in	8.386in	1000
HB 55 375/2	2.165in	16.26in	1000	HB 105 175/2	4.134in	9.37in	1000
HB 55 400/2	2.165in	17.244in	1000	HB 105 200/2	4.134in	10.354in	1000
HB 55 425/2	2.165in	18.228in	1000	HB 105 225/2	4.134in	11.339in	1000
HB 55 450/2	2.165in	19.213in	1000	HB 105 250/2	4.134in	12.323in	1000
HB 55 458/2	2.165in	19.528in	1000	HB 105 275/2	4.134in	13.307in	1000
HB 65 030/2	2.559in	2.953in	1000	HB 105 300/2	4.134in	14.291in	1000
HB 65 050/2	2.559in	3.74in	1000	HB 105 325/2	4.134in	15.276in	1000
HB 65 075/2	2.559in	4.724in	1000	HB 105 350/2	4.134in	16.26in	1000
HB 65 100/2	2.559in	5.709in	1000	HB 105 375/2	4.134in	17.244in	1000
HB 65 125/2	2.559in	6.693in	1000	HB 105 400/2	4.134in	18.228in	1000
HB 65 150/2	2.559in	7.677in	1000	HB 105 425/2	4.134in	19.213in	1000
HB 65 175/2	2.559in	8.661in	1000	HB 105 430/2	4.134in	19.409in	1000
HB 65 200/2	2.559in	9.646in	1000				

MH-Pack

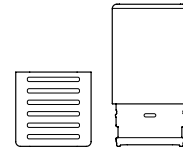

High-quality, stable packaging tube for the manufacturer and end user of modular milling heads

- perfect protection of sharp-edged and delicate milling heads
- efficient packing, secure and easy removal
- simple handling; easy to open and close due to incorporated grooves in the base
- the cap ensures injury-free and damage-free clamping of the tool changing head
- clamping strips for wrench size and shaft diameter provide a tight fit for the milling head
- perfect presentation of tool
- packaging can be labeled and sealed
- durable and reusable
- sturdy, oil, and moisture resistant



Perfect packaging for milling heads that combines maximum product protection with maximum user safety



PACKAGING

Base and cover are packed separately in individual cartons



MATERIAL

- Base made from impact resistant ABS
- Cover in Polypropylene (PP)



COLORS

- Cover in transparent
- Base in gray or in various attractive standard colors

HEAD LENGTHS

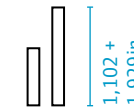

CUTTING EDGE DIAM.

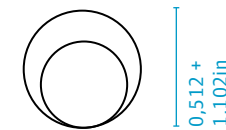

STANDARD COLORS



Product Range

Article	Part type	Wrench size SW	Shank diam.	max. cutting edge diam.	max. head length LM4	PU
MH 18x21/1 B	base					500
MH 18x4-8/1 C	cover	0.157in	0.236 - 0.315in	0.512in	1.102in	500
MH 18x4-10/1 C	cover	0.157in	0.315 - 0.394in	0.512in	1.102in	500
MH 18x5.5-10/1 C	cover	0.217in	0.315 - 0.394in	0.512in	1.102in	500
MH 18x5.5-12/1 C	cover	0.217in	0.394 - 0.472in	0.512in	1.102in	500
MH 18x6.5-13/1 C	cover	0.236in	0.236 - 0.315in	0.512in	1.102in	500
MH 18x6-8/1 C	cover	0.236in	0.315 - 0.394in	0.512in	1.102in	500
MH 18x6-10/1 C	cover	0.256in	0.433 - 0.512in	0.512in	1.102in	500
MH 18x8-10/1 C	cover	0.315in	0.315 - 0.394in	0.512in	1.102in	500
MH 18x8-12/1 C	cover	0.315in	0.394 - 0.472in	0.512in	1.102in	500
MH 18x10-12/1 C	cover	0.394in	0.394 - 0.472in	0.512in	1.102in	500
MH 36x35/1 B	base					350
MH 36x6.5-16/1 C	cover	0.63in	0.709 - 0.787in	w1.102in	1.929in	350
MH 36x7.7-16/1 C	cover	0.256in	0.551 - 0.63in	1.102in	1.929in	350
MH 36x8-16/1 C	cover	0.303in	0.551 - 0.63in	1.102in	1.929in	350
MH 36x9-20/1 C	cover	0.315in	0.551 - 0.63in	1.102in	1.929in	350
MH 36x10-13/1 C	cover	0.354in	0.709 - 0.787in	1.102in	1.929in	350
MH 36x12-16/1 C	cover	0.394in	0.433 - 0.512in	1.102in	1.929in	350
MH 36x13-16/1 C	cover	0.472in	0.551 - 0.63in	1.102in	1.929in	350
MH 36x16-20/1 C	cover	0.512in	0.551 - 0.63in	1.102in	1.929in	350
MH 36x20-25/1 C	cover	0.787in	0.906 - 0.984in	1.102in	1.929in	350
MH 36x21-25/1 C	cover	0.827in	0.906 - 0.984in	1.102in	1.929in	350

Awards



Micro Box MB1

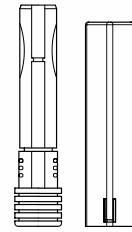

Packaging tubes for sensitive micro drills, precision drills, precision milling cutters and PCB drills

- optimum protection of tools thanks to complete coating of tool by back and outer part of packaging
- groove in bottom part makes opening easy
- fold back feature allows safe, secure reomoval of tool; available with or without shaft clamping device



PACKAGING

Outer parts and inner parts are packed separately in individual cartons



MATERIAL

- Polypropylene (PP)



COLORS

- Outer part in transparent; inner part in various attractive standard colors

USABLE LENGTHS

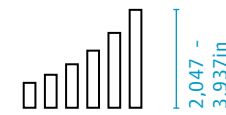

SHANK DIAM.

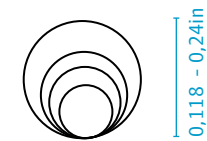

STANDARD COLORS



Product Range

Inner part

Article	Part type	Version	Shank diam.	Shank diam. (in.)	Clamping in base	Length stop at	PU
MB 1 3/1 I	inner part	1	0.118in		Yes	-	1000
MB 1 3.175/1 I	inner part	1	0.125in	1/8"	Yes	-	1000
MB 1 3.175/2 I	inner part	2	0.125in	1/8"	No	1.339in	1000
MB 1 3.175/3 I	inner part	3	0.125in	1/8"	Yes	1.339in	1000
MB 1 3.175/4 I	inner part	4	0.125in	1/8"	No	1.063in	1000
MB 1 3-6/1 I	inner part	1	0,118-0,236in		Yes	-	400
MB 1 3-6/2 I	inner part	2	0,118-0,236in		Yes	2.165in	400
MB 1 3-6/3 I	inner part	3	0,118-0,236in		Yes	2.953in	400
MB 1 3-6/5 I	inner part	5	0,118-0,236in		Yes	1.811in	400
MB 1 3-6/4 I	inner part	4	0,118-0,236in		Yes	1.417in	400
MB 1 3-6/6 I*	inner part	6	0,118-0,236in		Yes	1.811in	400

Version 1 without length stop. Versions 2-6 with length stop.

*Rear panel not foldable.

Outer part

Article	Part type	∅	Inner length	Suitable for	Usable length	PU
TPK 8x52 A	outer part	0,315in	2,047in	MB 1 /3 + MB 1 /3.175	2,047in	1000
TPK 8x70 A	outer part	0,315in	2,756in	MB 1 /3 + MB 1 /3.175	2,677in	1000
TPK 13x74 A	outer part	0,512in	2,913in	MB 1 /3-6	2,913in	500
TPK 13x97 A	outer part	0,512in	3,819in	MB 1 /3-6	3,937in	500

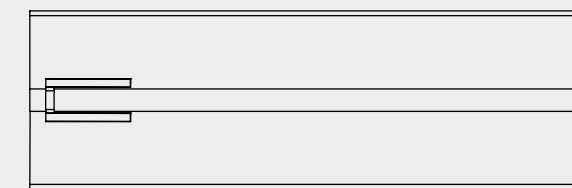
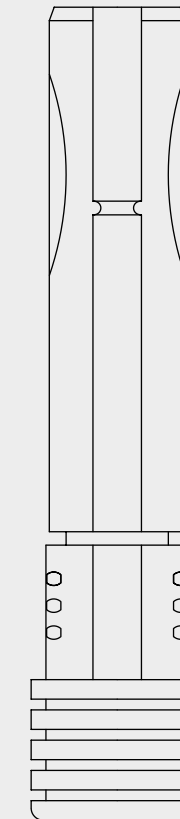

Small yet perfectly proportioned: the ideal packaging for micro drills and precision milling cutters

Micro Box Swing

High-quality plastic packaging tubes for sensitive solid carbide micro tools and premium shank tools

- optimum protection of tools
- easy loading and unloading of tools
- the tool can be extracted easily by pressing on the shank end of the pack
- flexible hinges on the inner part expose the tool shank socket
- an enlarged opening angle of 270° allows for non-contact removal and direct attachment of the tool to the desired machine
- tools are tightly secured by the clamping mechanism in the fold back design. Additional clamping is available by adding a

- soft layer of material to the clamping area to secure highly polished and smooth tool shanks
- durable hinge design creates reusability of the package
- coding by different color versions of the "PLUS" clamping device possible
- optimum visibility of content
- sturdy, oil, and moisture resistant

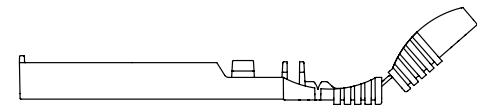

 **Maximum grip and easy handling. The ideal protective packaging for micro tools**



PACKAGING

Outer parts and inner parts are packed separately in individual cartons



MATERIAL

- Inner part: Polypropylene (PP)
- Inner part with "PLUS" clamping device: Polypropylen (PP) with TPE
- Outer part: Polypropylene (PP)



COLORS

- Outer parts and inner parts in transparent
- "PLUS" clamping device in natural
- Further colors and color combinations on request

LENGTHS

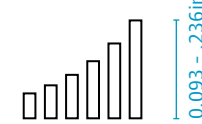

SHANK DIAM.

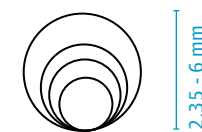

STANDARD COLORS

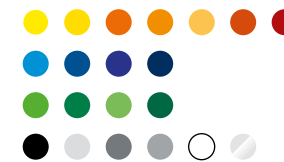

Product Range

Inner part

Article	Part type	∅	Shank diam.	PU
MBS 8x52-2.35/1 I	inner part	0.315in	0.093in	1000
MBS 8x52-3/1 I	inner part	0.315in	0.118in	1000
MBS 8x52-4/1 I	inner part	0.315in	0.157in	1000
MBS 8x52-6/1 I	inner part	0.315in	0.236in	1000
MBS 8x52-2.35/2 PLUS I	inner part w/ PLUS clamping	0.315in	0.093in	1000
MBS 8x52-3/2 PLUS I	inner part w/ PLUS clamping	0.315in	0.118in	1000
MBS 8x52-4/2 PLUS I	inner part w/ PLUS clamping	0.315in	0.157in	1000
MBS 8x52-6/2 PLUS I	inner part w/ PLUS clamping	0.315in	0.236in	1000
MBS 8x70-2.35/1 I	inner part	0.315in	0.093in	1000
MBS 8x70-3/1 I	inner part	0.315in	0.118in	1000
MBS 8x70-4/1 I	inner part	0.315in	0.157in	1000
MBS 8x70-6/1 I	inner part	0.315in	0.236in	1000
MBS 8x70-2.35/2 PLUS I	inner part w/ PLUS clamping	0.315in	0.093in	1000
MBS 8x70-3/2 PLUS I	inner part w/ PLUS clamping	0.315in	0.118in	1000
MBS 8x70-4/2 PLUS I	inner part w/ PLUS clamping	0.315in	0.157in	1000
MBS 8x70-6/2 PLUS I	inner part w/ PLUS clamping	0.315in	0.236in	1000

Outer part

Article	Part type	∅	Inner length	Suitable for	Usable length	PU
TPK 8x52 A	outer part	0.315in	2.047in	MBS 8x52	2,362in	1000
TPK 8x70 A	outer part	0.315in	2.756in	MBS 8x70	3,071in	1000

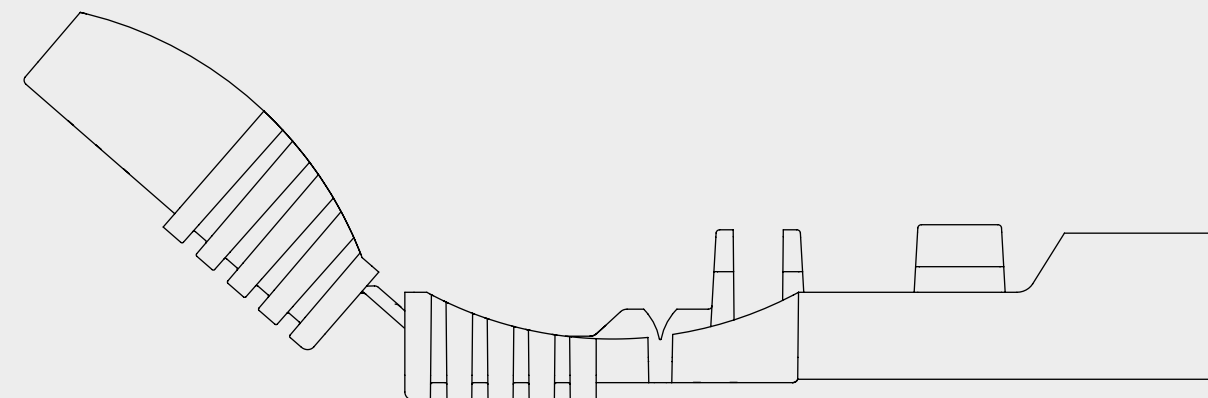

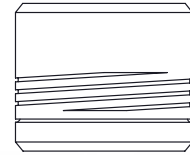

MK-Pack

Packaging and storage tubes for face milling cutters and shell end mills

- with secure twist closure
- tool is secured in the center of the pack by means of a spigot located in the tool arbor hole
- adaptor rings to accommodate various arbor hole sizes (to be plugged into the spigot insert)
- foam insert to be put into cover of pack for additional protection available
- easy handling
- durable and reusable
- sturdy, oil, and moisture resistant



Simple, safe, and solid.
No other packaging tube offers as much protection for heavyweights



PACKAGING

Outer parts and inner parts are packed assembled



MATERIAL

- Polyethylene (PE)
- Recycled plastic
- Bio plastic



COLORS

- Depending on the material natural or in various attractive standard



ACCESSORIES

- Center spigot insert
- Adapter ring
- Foam inserts (see page 180)

USABLE LENGTHS

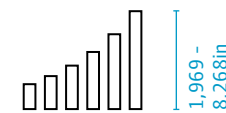

Ø DIAMETER

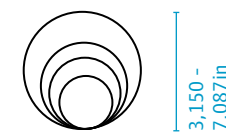

STANDARD COLORS



Product Range

MK-Pack

Article	Ø	Usable length	PU	Article	Ø	Usable length	PU
MK 80 050	3.15in	1.969 - 2.362in	170	MK 125 170	4.921in	6.693 - 7.087in	24
MK 80 070	3.15in	2.756 - 3.15in	120	MK 125 200	4.921in	7.874 - 8.268in	20
MK 80 090	3.15in	3.543 - 3.937in	100	MK 150 065	5.906in	2.559 - 2.953in	42
MK 80 110	3.15in	4.331 - 4.724in	80	MK 150 075	5.906in	2.953 - 3.346in	36
MK 80 130	3.15in	5.118 - 5.512in	80	MK 150 090	5.906in	3.543 - 3.937in	30
MK 100 060	3.937in	2.362 - 2.756in	95	MK 150 110	5.906in	4.331 - 4.724in	24
MK 100 070	3.937in	2.756 - 3.15in	70	MK 150 130	5.906in	5.118 - 5.512in	24
MK 100 090	3.937in	3.543 - 3.937in	65	MK 150 150	5.906in	5.906 - 6.299in	20
MK 100 110	3.937in	4.331 - 4.724in	60	MK 150 170	5.906in	6.693 - 7.087in	18
MK 100 130	3.937in	5.118 - 5.512in	50	MK 150 200	5.906in	7.874 - 8.268in	12
MK 100 150	3.937in	5.906 - 6.299in	45	MK 180 065	7.087in	2.559 - 2.953in	30
MK 100 170	3.937in	6.693 - 7.087in	39	MK 180 075	7.087in	2.953 - 3.346in	24
MK 100 200	3.937in	7.874 - 8.268in	32	MK 180 090	7.087in	3.543 - 3.937in	24
MK 125 065	4.921in	2.559 - 2.953in	56	MK 180 110	7.087in	4.331 - 4.724in	18
MK 125 075	4.921in	2.953 - 3.346in	50	MK 180 130	7.087in	5.118 - 5.512in	15
MK 125 090	4.921in	3.543 - 3.937in	40	MK 180 150	7.087in	5.906 - 6.299in	12
MK 125 110	4.921in	4.331 - 4.724in	35	MK 180 170	7.087in	6.693 - 7.087in	10
MK 125 130	4.921in	5.118 - 5.512in	30	MK 180 200	7.087in	7.874 - 8.268in	12
MK 125 150	4.921in	5.906 - 6.299in	25				

MK-Pack accessories

Article	Description	Suitable for	Shank diam.	Outer height	PU
Ring 25.4/22 (1)	adapter ring inch	ST 80/22, ST 100/22, ST 125/22, ST 150/22	1in		2000
Ring 31.75/22 (1.25)	adapter ring inch	ST 80/22, ST 100/22, ST 125/22, ST 150/22	1.25in		1500
Ring 38.1/22 (1.5)	adapter ring inch	ST 80/22, ST 100/22, ST 125/22, ST 150/22	1.5in		1500
Ring 50.8/40 (2)	adapter ring inch	ST 180/40	2in		1000
Ring RG 27/22	adapter ring metric	ST 80/22, ST 100/22, ST 125/22, ST 150/22	1.063in		2000
Ring RG 30/22	adapter ring metric	ST 80/22, ST 100/22, ST 125/22, ST 150/22	1.26in		1500
Ring RG 32/22	adapter ring metric	ST 80/22, ST 100/22, ST 125/22, ST 150/22	1.181in		1500
Ring RG 40/22	adapter ring metric	ST 80/22, ST 100/22, ST 125/22, ST 150/22	1.575in		1000
ST 80/22	center spigot insert	MK 80	0.866in	0.787in	300
ST 100/22	center spigot insert	MK 100	0.866in	0.787in	200
ST 125/22	center spigot insert	MK 125	0.866in	0.787in	120
ST 150/22	center spigot insert	MK 150	0.866in	0.787in	100
ST 180/38.1	center spigot insert	MK 180	1.5in	0.787in	80
ST 180/40	center spigot insert	MK 180	1.575in	0.787in	80

MultiPack

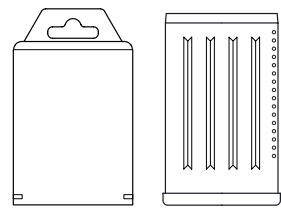

Set packaging solution for drill bits

- with telescopic ratchet feature for variable length adjustment
- available with or without hanger
- efficient packing, easy handling
- durable and reusable
- sturdy, oil, and moisture resistant



 The practical set packaging solution – when there's more than one tool to protect



PACKAGING

Outer parts and inner parts are packed separately in individual cartons



MATERIAL

- Polyvinylchloride (PVC)
- MP-A 5/7,5 and MP 5/7,5 also in Polypropylene (PP)



COLORS

- PVC clear, PP transparent or in various attractive standard colors or two-colored

USABLE LENGTHS

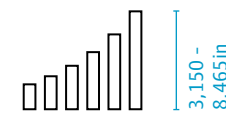

UNIT-Ø

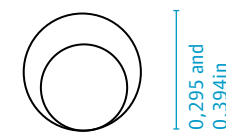

STANDARD COLORS

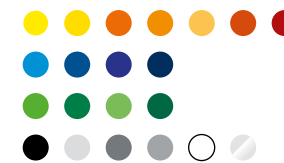

Product Range

Article	Description	Number of units	Inner diam. unit	Usable length adjustable	PU
MP-A 5/7.5-80	with hanger	5	0.295in	3.15 - 4.724in	500
MP-A 5/12-100	with hanger	5	0.394in	4.331 - 6.299in	500
MP-A 5/12-155	with hanger	5	0.394in	6.496 - 8.465in	350
MP-A 7/12-100	with hanger	7	0.394in	4.331 - 6.299in	280
MP 5/7,5-80	without hanger	5	0.295in	3.15 - 4.724in	500
MP 5/12-100	without hanger	5	0.394in	4.331 - 6.299in	500
MP 5/12-155	without hanger	5	0.394in	6.496 - 8.465in	500
MP 7/12-100	without hanger	7	0.394in	4.331 - 6.299in	280

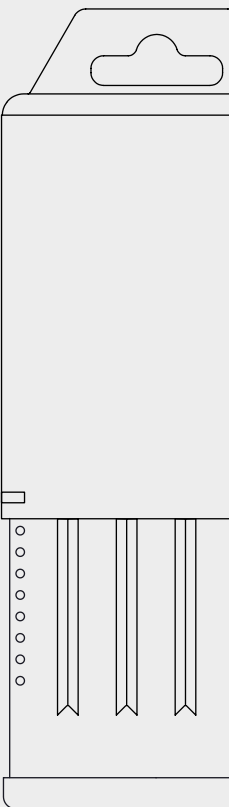



PlugPack

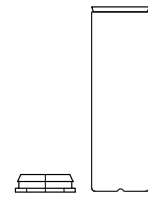

Round plastic packaging tubes in fixed length with secure plug-closure

- square plug prevents rolling
- available in different fixed lengths
- durable and reusable
- sturdy, oil, and moisture resistant



Oh so simple, oh so practical:
universal packaging tube
with the world's simplest
closure (probably)



PACKAGING

Tubes and plugs are packed separately in individual cartons



MATERIAL

- Tubes: Polypropylene (PP)
- Plugs: Polyethylene (PE)
- Recycled plastic



COLORS

- Depending on the material transparent, natural or in various attractive standard colors



ACCESSORIES

- Foam inserts (see page 180)

USABLE LENGTHS

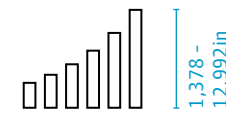

Ø DIAMETER



STANDARD COLORS



Product Range

Article	Inner diam.	Usable length	PU	Article	Inner diam.	Usable length	PU
TP 7 050 A + P 8	0.315in	1.969in	3200	TP 20 200 A + P 20	0.866in	7.874in	900
TP 7 075 A + P 8	0.315in	2.953in	3200	TP 20 220 A + P 20	0.866in	8.661in	780
TP 9 040 A + P 9	0.394in	1.378in	2000	TP 22 050 A + P-P 22	0.945in	1.969in	1000
TP 9 065 A + P 9	0.394in	2.559in	2000	TP 22 080 A + P-P 22	0.945in	3.15in	1300
TP 12 040 A + P 12	0.551in	1.575in	3000	TP 22 120 A + P-P 22	0.945in	4.724in	800
TP 12 045 A + P 12	0.551in	1.772in	3000	TP 22 200 A + P-P 22	0.945in	7.874in	750
TP 12 050 A + P 12	0.551in	1.969in	2900	TP 24 035 A + P-P 24	1.024in	1.378in	1400
TP 12 060 A + P 12	0.551in	2.362in	2200	TP 24 050 A + P-P 24	1.024in	1.969in	1900
TP 12 070 A + P 12	0.551in	2.756in	2200	TP 24 080 A + P-P 24	1.024in	3.15in	1200
TP 12 080 A + P 12	0.551in	3.15in	3500	TP 24 120 A + P-P 24	1.024in	4.724in	800
TP 12 120 A + P 12	0.551in	4.724in	2000	TP 24 200 A + P-P 24	1.024in	7.874in	650
TP 12 200 A + P 12	0.551in	7.874in	2100	TP 26 050 A + P-P 26	1.102in	1.969in	1700
TP 12 240 A + P 12	0.551in	9.449in	1600	TP 26 080 A + P-P 26	1.102in	3.15in	850
TP 14 035 A + P 14	0.63in	1.378in	2200	TP 26 120 A + P-P 26	1.102in	4.724in	550
TP 14 050 A + P 14	0.63in	1.969in	2200	TP 26 200 A + P-P 26	1.102in	7.874in	500
TP 14 060 A + P 14	0.63in	2.362in	1800	TP 26 330 A + P-P 26	1.102in	12.992in	320
TP 14 080 A + P 14	0.63in	3.15in	2800	TP 28 050 A + P 28	1.181in	1.969in	1400
TP 14 120 A + P 14	0.63in	4.724in	1600	TP 28 060 A + P 28	1.181in	2.362in	1000
TP 14 150 A + P 14	0.63in	5.906in	1200	TP 28 080 A + P 28	1.181in	3.15in	800
TP 14 200 A + P 14	0.63in	7.874in	1500	TP 28 120 A + P 28	1.181in	4.724in	500
TP 16 035 A + P 16	0.709in	1.378in	2400	TP 28 200 A + P 28	1.181in	7.874in	450
TP 16 050 A + P 16	0.709in	1.969in	1700	TP 30 050 A + P-P 30	1.299in	1.969in	1200
TP 16 080 A + P 16	0.709in	3.15in	2000	TP 30 080 A + P-P 30	1.299in	3.15in	650
TP 16 090 A + P 16	0.709in	3.543in	1800	TP 30 120 A + P-P 30	1.299in	4.724in	400
TP 16 120 A + P 16	0.709in	4.724in	1200	TP 30 150 A + P-P 30	1.299in	5.906in	350
TP 16 200 A + P 16	0.709in	7.874in	1200	TP 30 190 A + P-P 30	1.299in	7.48in	430
TP 16 250 A + P 16	0.709in	9.843in	900	TP 30 200 A + P-P 30	1.299in	7.874in	400
TP 18 050 A + P 18	0.787in	1.969in	1500	TP 30 270 A + P-P 30	1.299in	10.63in	3000
TP 18 080 A + P 18	0.787in	3.15in	1700	TP 32 050 A + P-P 32	1.378in	1.969in	1000
TP 18 120 A + P 18	0.787in	4.724in	1100	TP 32 080 A + P-P 32	1.378in	3.15in	650
TP 18 200 A + P 18	0.787in	7.874in	1000	TP 32 120 A + P-P 32	1.378in	4.724in	400
TP 18 250 A + P 18	0.787in	9.843in	800	TP 32 200 A + P-P 32	1.378in	7.874in	350
TP 20 050 A + P 20	0.866in	1.969in	1200				
TP 20 060 A + P 20	0.866in	2.362in	2000				
TP 20 070 A + P 20	0.866in	2.756in	2000				
TP 20 080 A + P 20	0.866in	3.15in	1500				
TP 20 120 A + P 20	0.866in	4.724in	1000				



QuadroPack

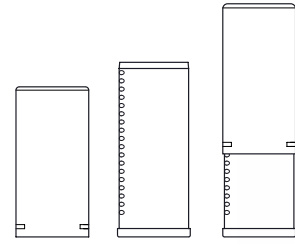

Square telescopic plastic packaging tubes with ratchet length adjustment

- infinitely variable length adjustment via ratchet feature
- speedy efficient packaging
- speedy handling
- excellent for stacking and storage
- durable and reusable
- sturdy, oil, and moisture resistant



Square, practical, easily closable – thanks to ratchet length adjustment. It's no accident that our cuboid multi-talent is among the world's best-selling packaging tubes



PACKAGING

Outer parts and inner parts are packed separately in individual cartons



MATERIAL

- Polyethylene (PE)
- Polypropylene (PP)
- Polyvinylchloride (PVC)
- Recycled plastic
- Bio plastic



COLORS

- Depending on the material transparent, natural or in various attractive standard colors or two-color



ACCESSORIES

- With hangers on request
- Foam inserts (see page 180)

USABLE LENGTHS

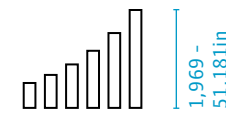

Ø DIAMETER

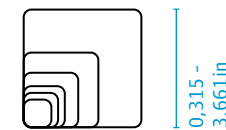

STANDARD COLORS

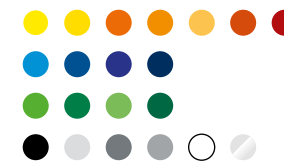

Product Range

Article	Inner diam.	Usable length	PU	Article	Inner diam.	Usable length	PU
QP 8 050	0.315in	1.969 - 3.15in	2700	QP 26 080	1.024in	3.15 - 4.724in	1000
QP 8 080	0.315in	3.15 - 4.724in	1700	QP 26 100	1.024in	3.937 - 6.299in	800
QP 8 120	0.315in	4.724 - 7.874in	2000	QP 26 120	1.024in	4.724 - 7.874in	600
QP 8 200	0.315in	7.874 - 13.78in	2000	QP 26 200	1.024in	7.874 - 13.78in	600
QP 10 050	0.394in	1.969 - 3.15in	2100	QP 26 350	1.024in	13.78 - 24.409in	340
QP 10 080	0.394in	3.15 - 4.724in	2600	QP 32 050	1.26in	1.969 - 2.756in	1400
QP 10 120	0.394in	4.724 - 7.874in	1400	QP 32 060	1.26in	2.362 - 3.15in	1000
QP 10 200	0.394in	7.874 - 13.78in	1550	QP 32 080	1.26in	3.15 - 4.724in	700
QP 10 250	0.394in	9.843 - 18.11in	1200	QP 32 120	1.26in	4.724 - 7.874in	450
QP 12 050	0.472in	1.969 - 3.15in	3000	QP 32 200	1.26in	7.874 - 13.78in	420
QP 12 070	0.472in	2.756 - 4.331in	2000	QP 32 350	1.26in	13.78 - 24.409in	208
QP 12 080	0.472in	3.15 - 4.724in	1800	QP 34 100	1.339in	3.937 - 6.299in	450
QP 12 120	0.472in	4.724 - 7.874in	1000	QP 35 050	1.378in	1.969 - 2.756in	1000
QP 12 200	0.472in	7.874 - 13.78in	1000	QP 35 060	1.378in	2.362 - 3.15in	750
QP 12 250	0.472in	9.843 - 18.11in	850	QP 35 080	1.378in	3.15 - 4.724in	600
QP 14 050	0.551in	1.969 - 3.15in	2300	QP 35 120	1.378in	4.724 - 7.874in	350
QP 14 060	0.551in	2.362 - 3.346in	2000	QP 35 200	1.378in	7.874 - 13.78in	320
QP 14 065	0.551in	2.559 - 3.937in	2000	QP 35 300	1.378in	11.811 - 21.26in	210
QP 14 080	0.551in	3.15 - 4.724in	1300	QP 35 350	1.378in	13.78 - 24.409in	168
QP 14 120	0.551in	4.724 - 7.874in	800	QP 45 060	1.772in	2.362 - 3.15in	450
QP 14 200	0.551in	7.874 - 13.78in	800	QP 45 080	1.772in	3.15 - 4.724in	300
QP 14 300	0.551in	11.811 - 21.063in	500	QP 45 120	1.772in	4.724 - 7.874in	335
QP 16 050	0.709in	1.969 - 3.15in	2000	QP 45 200	1.772in	7.874 - 13.78in	180
QP 16 080	0.709in	3.15 - 4.724in	1100	QP 45 350	1.772in	13.78 - 24.409in	99
QP 16 120	0.709in	4.724 - 7.874in	1400	QP 45 700	1.772in	27.559 - 51.181in	99
QP 16 200	0.709in	7.874 - 13.78in	1400	QP 55 060	2.165in	2.362 - 3.15in	300
QP 18 050	0.787in	1.969 - 3.15in	1500	QP 55 080	2.165in	3.15 - 4.724in	288
QP 18 080	0.787in	3.15 - 4.724in	1800	QP 55 120	2.165in	4.724 - 7.874in	200
QP 18 120	0.787in	4.724 - 7.874in	1100	QP 55 200	2.165in	7.874 - 13.78in	120
QP 18 200	0.787in	7.874 - 13.78in	1100	QP 55 350	2.165in	13.78 - 24.409in	72
QP 20 050	0.787in	13.78 - 24.409in	1200	QP 65 080	2.559in	3.15 - 4.724in	210
QP 20 080	0.866in	1.969 - 3.15in	1600	QP 65 120	2.559in	4.724 - 7.874in	155
QP 20 120	0.866in	2.953 - 4.134in	900	QP 65 200	2.559in	7.874 - 13.78in	92
QP 20 200	0.866in	3.15 - 4.724in	900	QP 65 300	2.559in	11.811 - 20.472in	65
QP 20 350	0.866in	4.724 - 7.874in	500	QP 65 350	2.559in	13.78 - 24.409in	56
QP 22 050	0.866in	7.874 - 13.78in	1200	QP 78 080	3.071in	3.15 - 4.724in	160
QP 22 075	0.945in	1.969 - 3.15in	1500	QP 78 120	3.071in	4.724 - 7.874in	105
QP 22 080	0.945in	3.15 - 4.724in	1300	QP-G78150	3.071in	5.906 - 9.843in	80
QP 22 120	0.945in	4.724 - 7.874in	850	QP 78 220	3.071in	8.661 - 13.78in	56
QP 22 200	0.945in	7.874 - 13.78in	840	QP 78 320	3.071in	12.598 - 17.717in	42
QP 24 050	1.024in	1.969 - 2.362in	850	QP 93 080	3.661in	3.15 - 4.724in	90
QP 24 080	1.024in	2.362 - 3.15in	1000	QP 93 120	3.661in	4.724 - 7.874in	75
QP 24 120	24mm	120 - 200mm	650	QP 93 200	3.661in	7.874 - 13.78in	48
QP 24 200	24mm	200 - 350mm	600	QP 93 280	3.661in	11.024 - 17.717in	30
QP 26 050	26mm	50 - 60mm	1400				
QP 26 060	26mm	60 - 80mm	1400				

QP-G 78 150 with recessed bottom



RectangularPack

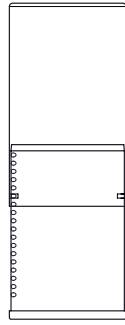

Rectangular telescopic plastic packaging tubes with ratchet length adjustment

- infinitely variable telescopic length adjustment
- speedy efficient packaging
- speedy handling
- excellent for stacking and storage
- durable and reusable
- sturdy, oil, and moisture resistant



Not everything is round or square – which is why we created this practical packaging tube for everything that's on the flatter side



PACKAGING

Outer parts and inner parts are packed separately in individual cartons



MATERIAL

- Polyethylene (PE)
- Polypropylene (PP)
- Polyvinylchloride (PVC)
- Recycled plastic
- Bio plastic



COLORS

- Depending on the material transparent, natural or in various attractive standard colors or two-color



ACCESSORIES

- With hangers on request

USABLE LENGTHS

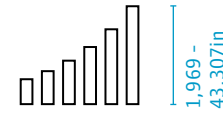

DIMENSION

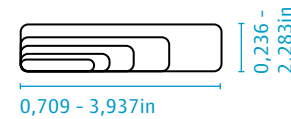

STANDARD COLORS

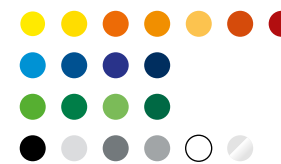

Product Range

RectangularPack

Article	Inner depth	Inner width	Usable length adjustable	PU	Article	Inner depth	Inner width	Usable length adjustable	PU
RP 6x20/050	0.236in	0.787in	1.969 - 3.15in	2000	RP 18x42/200	0.709in	1.654in	7.874 - 14.173in	408
RP 6x20/080	0.236in	0.787in	3.15 - 4.724in	1000	RP 18x42/240	0.709in	1.654in	9.449 - 16.535in	180
RP 6x20/120	0.236in	0.787in	4.724 - 7.874in	1000	RP 18x42/335	0.709in	1.654in	13.189 - 22.835in	280
RP 6x20/200	0.236in	0.787in	7.874 - 14.173in	1000	RP 18x42/620	0.709in	1.654in	24.409 - 43.307in	180
RP 8x36/050	0.315in	1.417in	1.969 - 3.15in	1600	RP 19x26/245	0.748in	1.024in	9.646 - 16.929in	550
RP 8x36/080	0.315in	1.417in	3.15 - 4.724in	1000	RP 19x31/270	0.748in	1.22in	10.63 - 18.504in	400
RP 8x36/138	0.315in	1.417in	5.433 - 9.449in	450	RP 19x31/295	0.748in	1.22in	11.614 - 20.472in	360
RP 8x36/240	0.315in	1.417in	9.449 - 16.535in	480	RP-A 23x33/090 ¹	0.906in	1.299in	3.543 - 5.512in	700
RP 8x36/420	0.315in	1.417in	16.535 - 30.709in	190	RP 25x33/080	0.984in	1.299in	3.15 - 4.724in	700
RP 8x36/820	0.315in	1.417in	32.283 - 43.307in	190	RP 26x31/270	1.024in	1.22in	10.63 - 18.504in	330
RP 9x45/080	0.354in	1.772in	3.15 - 4.724in	550	RP 26x42/060	1.024in	1.654in	2.362 - 3.15in	700
RP 9x45/120 I	0.354in	1.772in	4.724 - 6.299in	750	RP 26x42/080	1.024in	1.654in	3.15 - 4.724in	-
RP 9x45/160 I	0.354in	1.772in	6.299 - 7.874in	270	RP 26x42/120	1.024in	1.654in	4.724 - 7.874in	400
RP-A 10x22/100 A ¹	0.394in	0.866in	3.937 - 0in	750	RP 26x42/220	1.024in	1.654in	8.661 - 14.961in	320
RP-G 10x22/124 P ²	0.394in	0.866in	4.882 - 6.89in	750	RP 26x42/335	1.024in	1.654in	13.189 - 22.835in	200
RP-G 10x22/251 P ²	0.394in	0.866in	9.882 - 11.811in	250	RP 29x36/080	1.22in	2.205in	17.52 - 30.709in	700
RP-G 10x22/350 P ²	0.394in	0.866in	13.78 - 15.748in	300	RP 30x65/055	1.142in	1.417in	3.15 - 4.724in	650
RP 10x18/080	0.394in	0.709in	3.15 - 4.724in	1200	RP 30x65/070	1.181in	2.559in	2.165 - 2.756in	520
RP 10x18/120	0.394in	0.709in	4.724 - 7.874in	1500	RP 30x65/100	1.181in	2.559in	2.756 - 3.937in	350
RP 10x27/070 I	0.394in	1.063in	2.756 - 4.331in	850	RP 30x65/130	1.181in	2.559in	3.937 - 5.906in	385
RP 10x27/080	0.394in	1.063in	3.15 - 4.724in	850	RP 30x65/160	1.181in	2.559in	5.118 - 7.874in	300
RP 10x33/120	0.394in	1.299in	4.724 - 7.874in	500	RP 30x65/250	1.181in	2.559in	6.299 - 10.236in	180
RP 10x33/320	0.394in	1.299in	12.598 - 21.654in	240	RP 30x65/300	1.181in	2.559in	9.843 - 17.717in	160
RP 12x26/200	0.472in	1.024in	7.874 - 14.173in	480	RP 31x56/445	1.181in	2.559in	11.811 - 21.654in	100
RP 12x36/360	0.472in	1.417in	14.173 - 24.409in	330	RP 33x42/050	1.299in	1.654in	1.969 - 3.15in	800
RP 14x36/080	0.551in	1.417in	3.15 - 4.724in	650	RP 33x42/335	1.299in	1.654in	13.189 - 22.835in	165
RP 16x36/050	0.63in	1.417in	1.969 - 3.15in	700	RP 36x62/445	1.417in	2.441in	17.52 - 30.709in	80
RP 16x36/080	0.63in	1.417in	3.15 - 4.724in	600	RP 40x65/310	1.575in	2.559in	12.205in	105
RP 16x36/120	0.63in	1.417in	4.724 - 7.874in	350	RP 40x65/540	1.575in	2.559in	21.26in	110
RP 16x36/200	0.63in	1.417in	7.874 - 14.173in	350	RP 40x75/055	1.575in	2.953in	2.165 - 2.756in	450
RP 16x36/360 I	0.63in	1.417in	14.173 - 0in	200	RP 40x75/070	1.575in	2.953in	2.756 - 3.937in	350
RP 16x55/120	0.63in	2.165in	4.724 - 7.874in	450	RP 40x75/100	1.575in	2.953in	3.937 - 5.906in	320
RP 16x55/200	0.63in	2.165in	7.874 - 14.173in	370	RP 40x75/150	1.575in	2.953in	5.906 - 9.843in	200
RP-A 17x24/065 ¹	0.669in	0.945in	2.559 - 3.543in	1800	RP 40x75/210	1.575in	2.953in	8.268 - 14.173in	150
RP 18x42/050	0.709in	1.654in	1.969 - 3.15in	1000	RP 40x75/250	1.575in	2.953in	9.843 - 17.717in	120
RP 18x42/080	0.709in	1.654in	3.15 - 4.724in	850	RP 40x75/400	1.575in	2.953in	15.748 - 27.559in	70
RP 18x42/120	0.709in	1.654in	4.724 - 7.874in	450	RP 40x100/150	1.575in	3.937in	5.906 - 9.843in	132

¹ with hanger, ² for reciprocating saw blades

RectangularPack 58x78

Article	Inner dimension	Length outer part min.- max.	Length inner part min.- max.	Total usable length
RP 58x78	58x78	2,362-17,323in	0,394-15,354in	32,677in

RectangularPack MultiBox

Article	Inner dimension	Description	Length outer part min.- max.	Usable length fix
RP 30x65	30x65	cover	1,969-5,709in	2,362-6,102in
RP 30x65/G	30x65	base	1,575in	
RP 40x75	40x75	cover	1,969-3,740in	2,362-4,134in
RP 40x75/G	40x75	base	2,047in	

RoseSet

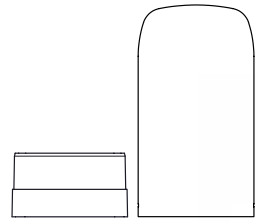

Modern, eye-catching set packaging for presentation, storage and transport. Ideal for sets of all kinds of tools and promotional items

- universal applications
- attractive and handy design
- smart, secure and simple closure
- crystal clear material of cover offers optimum presentation
- can be printed or enhanced by labeling, card inserts, etc.
- 25 or 35 mm recess in base will take punched foam inserts for set layout (not included with RoseSet)



A good tool set always pleases. All the more so if it's perfectly presented – just like this practical set packaging



PACKAGING

Outer parts and inner parts are packed separately in individual cartons



MATERIAL

- Base: Polystyrene (PS)
- Cover: Polyvinylchloride (PVC)



COLORS

- Base in blue and red; cover in transparent
- Please inquire for additional colors



ACCESSORIES

- Standard version without euro hanger; please inquire for version with euro hanger

USABLE LENGTHS

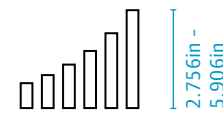

DIMENSION

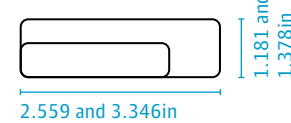

STANDARD COLORS



Product Range

Article	Inner width	Inner height	Usable length	Shank depth	PU
RoseSet 30x65/1/100	1.181in	2.559in	3.661in	0.984in	140
RoseSet 30x65/1/150	1.181in	2.559in	5.63in	0.984in	210
RoseSet 35x85/1/80	1.378in	3.346in	2.756in	0.984in	420
RoseSet 35x85/2/80	1.378in	3.346in	3.15in	1.378in	420
RoseSet 35x85/1/110	1.378in	3.346in	3.937in	0.984in	420
RoseSet 35x85/2/110	1.378in	3.346in	4.331in	1.378in	420
RoseSet 35x85/1/150	1.378in	3.346in	5.512in	0.984in	420
RoseSet 35x85/2/150	1.378in	3.346in	5.906in	1.378in	420

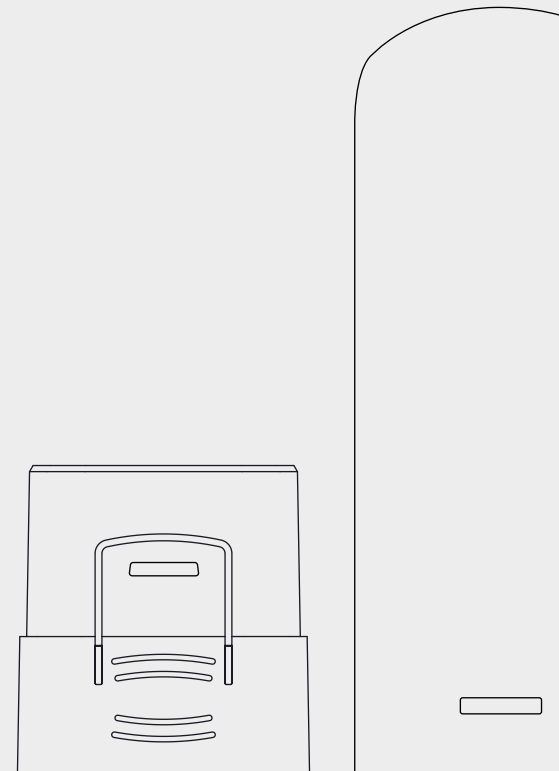

RoundDial-a-Tool

Round plastic containers – ideal set packaging for drill bits, countersinks, jigsaw blades and bits

- compact and stable
- easy twist locking system
- printing on base possible



A well-rounded solution: our set packaging with space for an all-round inscription – timeless, practical, effective



PACKAGING

Outer parts and inner parts are packed separately in individual cartons



MATERIAL

– Polystyrene (PS)



COLORS

– Cover in clear, base in white
– Please inquire for additional colors



ACCESSORIES

– Hanger

LENGTHS

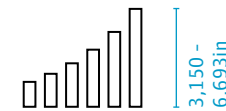

STANDARD COLOR



Product Range

Article	Number of holding devices	Suitable for	Index design	Outer height	PU
RD 01-9460	10	Bits+Magnetic holder	9 bits+1 bit holder 65mm	3.15in	150
RD 01-9861	10	Bits+Magnetic holder	9 bits+1 bit holder 75mm	3.15in	150
RD 02-9370	10	Bits+Magnetic holder	9 bits+1 bit holder 65mm	3.543in	100
RD 02-9858	10	Bits+Magnetic holder	9 bits+1 bit holder 75mm	3.543in	100
RD 03-8375	7	HSS drills	1/16"-1/4"x1/32"	4.921in	100
RD 03-8376	10	HSS drills	1/16"-1/4"	4.921in	100
RD 03-8377	13	HSS drills	1/16"-1/4"x1/64"	4.921in	100
RD 03-8427	13	HSS drills	1-7x0.5mm	4.921in	100
RD 03-9304	10	HSS/Masonry		4.921in	100
RD 03-9371	7	HSS drills	1.5/2/3/4/5/5.5/6mm	4.921in	100
RD 03-9373	13	HSS drills	1.5-6.5x0.5mm+3.3mm+4.2mm	4.921in	100
RD 03-9377	13	HSS drills	1/16"-1/4"x1/64"	4.921in	100
RD 03-9899	11	Saw blades	Saw blades max. lenght 100mm	4.921in	100
RD 04-8381	21	HSS drills	1/16"-3/8"x1/64"	5.709in	72
RD 04-9380	19	HSS drills	1.0-10.0x0.5mm	5.709in	72
RD 04-9382	18	HSS/Masonry/Wood	je 3/4/5/6/8/10mm	5.709in	72
RD 04-9385	18	HSS/Masonry/Wood	je 3/4/5/6/7/8mm	5.709in	72
RD 04-9955	13	Masonry drills	3-10mm	5.709in	72
RD 04-9969	19	HSS/Masonry	1-6x0.5+8+10+4/5/6/8/9/10mm	5.709in	72
RD 05-9680	7	SDS drills		6.693in	70
RD 05-9683	7	SDS drills	5/6x110mm	6.693in	70
RD 05-9689	7	SDS drills	5/6/8x110mm	6.693in	70
RD 06-9810	6	Countersinks	90mm	3.937in	50
RD 07-8380	19	HSS drills	1-10x0.5mm ANSI	5.709in	50
RD 07-8381	21	HSS drills	1/16"-3/8"x1/64"	5.709in	50
RD 07-9365	19	HSS/Masonry/Wood	je 3/4/5/6/8/10mm+center punch	5.709in	50
RD 07-9380	19	HSS drills	1.0-10.0x0.5mm	5.709in	50
RD 07-9382	18	HSS/Masonry/Wood	je 3/4/5/6/8/10mm	5.709in	50
RD 07-9385	18	HSS/Masonry/Wood	je 3/4/5/6/7/8mm	5.709in	50
RD 07-9388	20	HSS drills	1.0-10.0x0.5mm+1 center punch	5.709in	50
RD 07-9675	18	HSS/Masonry	2/3/4/5/6/8+4/5/6/8/10+6Bits+M	5.709in	50
RD 07-9693	11	HSS/Masonry/Wood	3/4/5/6mm+5/6/8mm+4/5/6/8mm	5.709in	50
RD 07-9719	12	Masonry drills	3/4/4/5/5/6/6/7/8/8/9/10mm	5.709in	50
RD 07-9733	15	Masonry drills	3-10x0.5mm	5.709in	50
RD 07-9955	13	Masonry drills	3-10mm	5.709in	50
RD 07-9969	19	HSS/Masonry	1-6x0.5+8+10+4/5/6/8/9/10mm	5.709in	50
RD 08-9883	18	Bits+Magnetic holder	17 Bits+Magnetic holder	3.543in	90



ChuckPack

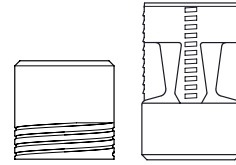

Protective packaging tubes for SK 40/SK 45/SK 50 steep taper tool holders

- tool is safely locked in packaging
- speedy efficient packaging
- easy removing
- extremely strong
- durable and reusable
- length adjustable cover
- round and square base available



Protect your steep taper tool holder – in this sturdy and secure special packaging



PACKAGING

Outer parts and inner parts are packed separately in individual cartons



MATERIAL

- Polyethylene (PE)
- Recycled plastic
- Bio plastic



COLORS

- Depending on the material natural or in various attractive standard colors



ACCESSORIES

- Foam inserts (see page 180)

TOOL LENGTHS

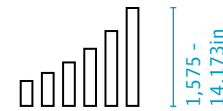

SUITABLE FOR

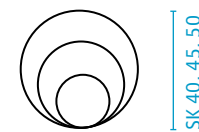

STANDARD COLORS



Product Range

ChuckPack SK 40

Article	Description	Suitable for	Length	For tool length (w/o cone)	PU
SK 40 095 A	cover no. 1/95	tool holder SK 40	3.74in	1.575 - 4.134in	180
SK 40 160 A	cover no. 2/160	tool holder SK 40	6.299in	4.134 - 6.299in	120
SK 40 225 A	cover no. 3/225	tool holder SK 40	8.858in	6.299 - 8.858in	80
SK 40 290 A	cover no. 4/290	tool holder SK 40	11.417in	8.858 - 11.417in	64
SK 40 355 A	cover no. 5/355	tool holder SK 40	13.976in	11.417 - 13.976in	50
SK 40-4K I	base square	tool holder SK 40			140
SK 40 I	base round	tool holder SK 40			140

ChuckPack SK 45

Article	Description	Suitable for	Length	For tool length (w/o cone)	PU
SK 45 103 A	cover no. 1/103	tool holder SK 45	4.055in	1.772 - 4.134in	100
SK 45 168 A	cover no. 2/168	tool holder SK 45	6.614in	4.134 - 6.496in	60
SK 45 233 A	cover no. 3/233	tool holder SK 45	9.173in	6.496 - 9.055in	44
SK 45 298 A	cover no. 4/298	tool holder SK 45	11.732in	9.055 - 11.614in	36
SK 45 363 A	cover no. 5/363	tool holder SK 45	14.291in	11.614 - 14.173in	25
SK 45-4K I	base square	tool holder SK 45			65

ChuckPack SK 50

Article	Description	Suitable for	Length	For tool length (w/o cone)	PU
SK 50 113 A	cover no. 1/113	tool holder SK 50	4.449in	1.772 - 4.331in	65
SK 50 178 A	cover no. 2/178	tool holder SK 50	7.008in	4.331 - 6.89in	39
SK 50 243 A	cover no. 3/243	tool holder SK 50	9.567in	6.89 - 9.449in	26
SK 50 308 A	cover no. 4/308	tool holder SK 50	12.126in	9.449 - 12.008in	20
SK 50 358 A	cover no. 5/358	tool holder SK 50	14.094in	12.008 - 13.976in	18
SK 50-4K I	base square	tool holder SK 50			39
SK 50 I	base round	tool holder SK 50			39

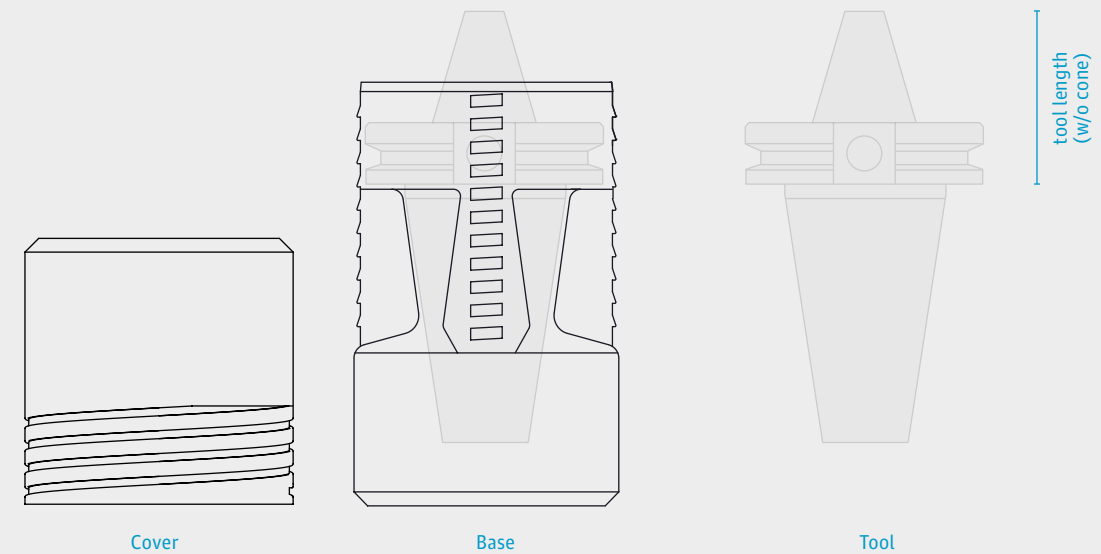



SK-Pack CenterLock

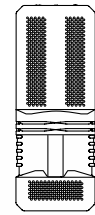

Protective packaging tubes with Center-Lock closure technology – ideal for steep taper tool holders SK 40 and SK 50

- simple handling due to "Center-Lock closure technology"
- efficient packaging - fast & easy loading and unpacking
- highly secure closure, but with minimal force in opening and closing the pack
- perfect protection by optimized product design and sturdy, impact resistant polyethylene
- variable length adjustment
- dimpled surface structure assists in providing a "non-slip" feature for stacking and storage
- durable and reusable
- taper shank is safely locked in the packaging
- embossing of customer brandings possible
- sturdy, oil, and moisture resistant



Centers and protects your steep taper tool holder – a safe bet



PACKAGING

Outer parts and inner parts are packed separately in individual cartons



MATERIAL

- Polyethylene (PE)
- Recycled plastic
- Bio plastic



COLORS

- Depending on the material natural or in various attractive standard colors

TOOL LENGTHS

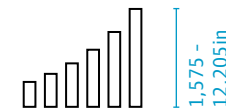

SUITABLE FOR

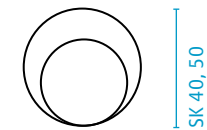

STANDARD COLORS



Product Range

SK-Pack CenterLock SK 40

Article	Description	Suitable for	Length	For tool length (w/o cone)	PU
SKCL 40 110/2 A	cover w/dimpled surface	tool holder SK 40	4.331in	1.575 - 3.937in	150
SKCL 40 180/2 A	cover w/dimpled surface	tool holder SK 40	7.087in	4.331 - 6.693in	90
SKCL 40 250/2 A	cover w/dimpled surface	tool holder SK 40	9.843in	7.087 - 9.449in	73
SKCL 40 320/2 A	cover w/dimpled surface	tool holder SK 40	12.598in	9.843 - 12.205in	50
SKCL 40/2 I	base w/ dimpled surface	tool holder SK 40			105

SK-Pack CenterLock SK 50

Article	Description	Suitable for	Length	For tool length (w/o cone)	PU
SKCL 50 110/2 A	cover w/dimpled surface	tool holder SK 50	4.331in	1.575 - 3.937in	60
SKCL 50 180/2 A	cover w/dimpled surface	tool holder SK 50	7.087in	4.331 - 6.693in	40
SKCL 50 250/2 A	cover w/dimpled surface	tool holder SK 50	9.843in	7.087 - 9.449in	28
SKCL 50 320/2 A	cover w/dimpled surface	tool holder SK 50	12.598in	9.843 - 12.205in	20
SKCL 50/2 I	base w/ dimpled surface	tool holder SK 50			40

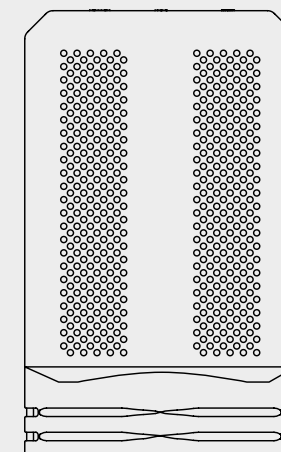

Cover

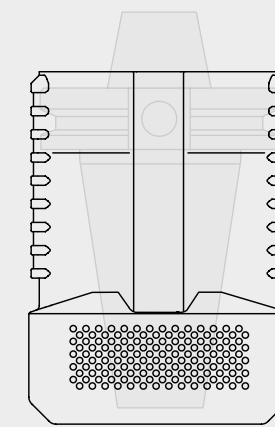

Base

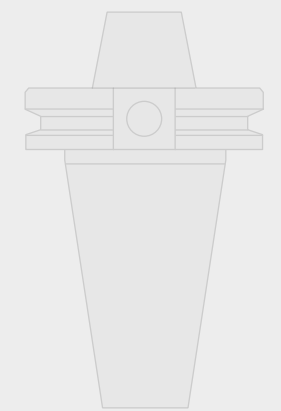

Tool

tool length (w/o cone)

SlimPack

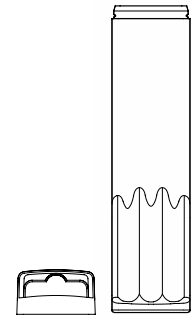

Transparent, thin-walled plastic packaging tube – ideal for SDS drills

- highly transparent plastic maximises product visibility
- thin walled plastic for ultra light weight
- unbreakable high-quality polystyrene offers stability and perfect protection
- plug with integrated euroslot
- durable and reusable
- easy to equip with cardboard inserts, labels etc.



PACKAGING

Outer parts and inner parts are packed separately in individual cartons



MATERIAL

- Tube: Polystyrene (PS)
- Hanger: Polypropylene (PP)



COLORS

- Tube in transparent, hanger in in various attractive standard colors

LENGTH

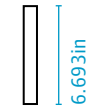

DIMENSION

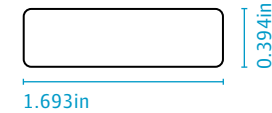

STANDARD COLORS

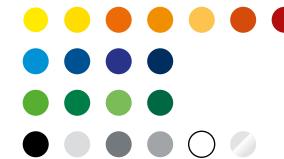

Product Range

Article	Description	Inner width	Inner depth	Inner length	PU
SLH 10x43/1	hanger	1.693in	0.394in		2500
SLT 10x43x170/4	tube, 3 compartments Ø10 mm	1.693in	0.394in	6.693in	450



Your tools need protection and visibility – not unnecessary bells and whistles. This proven protective packaging understands what product presentation really means

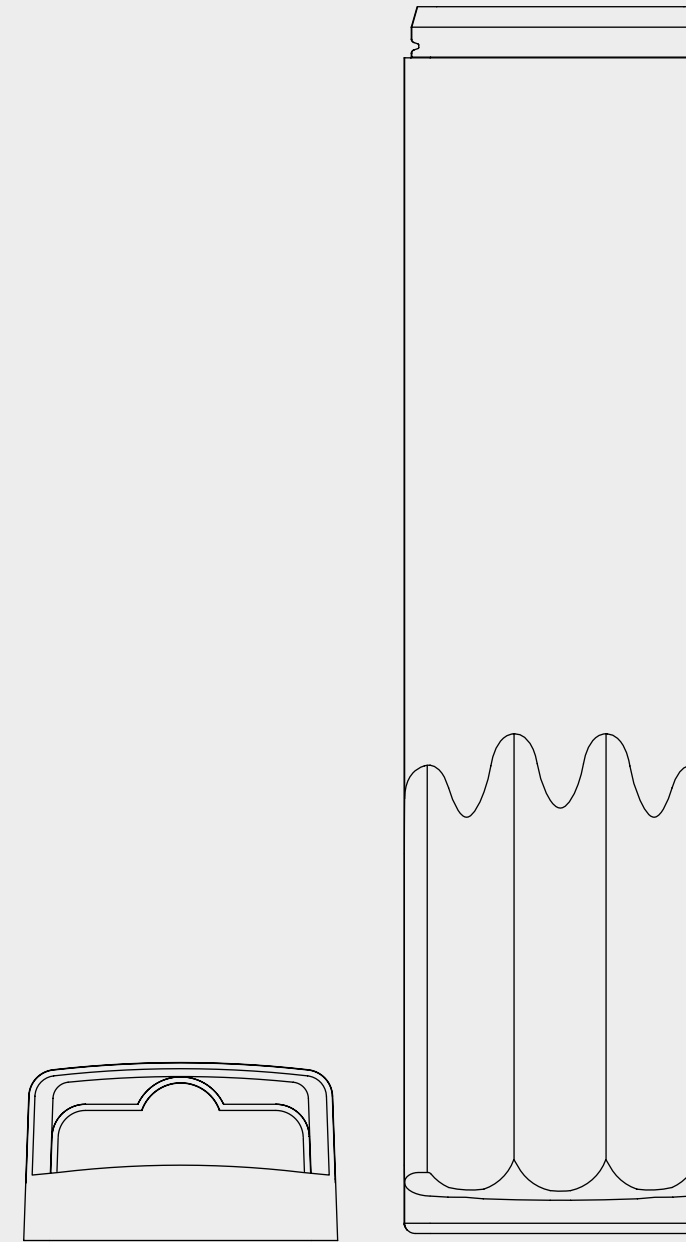



SZ-PlugPack

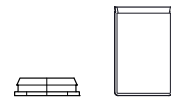

Plastic packaging tubes with secure plug-closure – ideal storage solution for ER collets

- fixed length tube designed to accommodate ER collets
- sturdy packaging tube with secure plug-closure
- square plug prevents rolling
- extremely strong
- durable and reusable
- oil resistant



PACKAGING

Tubes and Plugs are packed separately in individual cartons



MATERIAL

- Tube: Polypropylene (PP)
- Plug: Polyethylene (PE)
- Recycled plastic



COLORS

- Depending on the material transparent, natural or in various attractive standard colors

USABLE LENGTHS

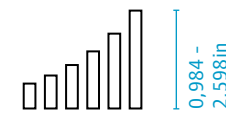

Ø DIAMETER



STANDARD COLORS



Product Range

Tubes

Article	Part type	Inner diam.	Inner length	Suitable for ER collets	PU
SZ 9 025	outer part	0.394in	0.984in	ER 8 Ø8.5 x L=13.5mm	5000
SZ 12 025	outer part	0.551in	0.984in	ER 11 Ø11.5 x L=18mm	2500
SZ 16 030	outer part	0.709in	1.181in	ER 16 Ø17 x L=27.5mm	2500
SZ 20 032	outer part	0.866in	1.26in	ER 20 Ø21 x L=31.5mm	2000
SZ 24 038	outer part	1.024in	1.496in	ER 25 Ø26 x L=34mm	1200
SZ 24 045	outer part	1.024in	1.811in	ER 25	1000
SZ 32 040	outer part	1.378in	1.654in	ER 32 Ø33 x L=40mm	1400
SZ 32 055	outer part	1.378in	2.283in	ER 32	1000
SZ 42 045	outer part	1.732in	1.89in	ER 40 Ø41 x L=46mm	750
SZ 42 065	outer part	1.732in	2.598in	ER 40	500

Plugs

Article	Part type	Diameter	Suitable for	PU
PZ 09	plug	0.63in	SZ 9 025	5000
PZ 12	plug	0.354in	SZ 12 025	2500
PZ 16	plug	0.472in	SZ 16 030	2500
PZ 20	plug	0.787in	SZ 20 032	2000
PZ 24	plug	0.945in	SZ 24 038 + SZ 24 045	2000
PZ 32	plug	1.26in	SZ 32 040 + SZ 32 055	1500
PZ 42	plug	1.654in	SZ 42 045 + SZ 42 065	1000



So simple and useful that there's not much to say. Put the plug on it – and your product is perfectly protected



TelePack

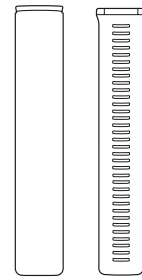

Round telescopic plastic packaging tubes with ratchet length adjustment and roll-away protection

- telescopic length extension, ratchet mechanism locks package into extended position
- square end prevents rolling
- durable and reusable
- sturdy, oil, and moisture resistant

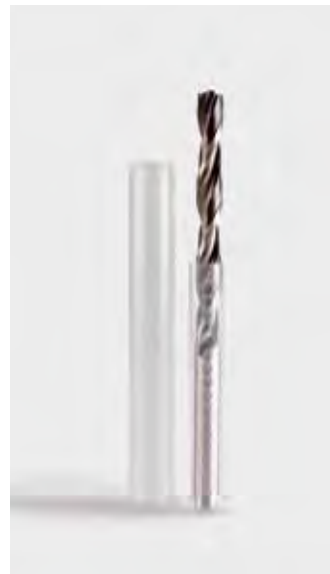

The telescopic length adjustment was the inspiration for the name of this practical and versatile packaging tube – a sought-after classic in our product range



PACKAGING

Outer parts and inner parts are packed separately in individual cartons



MATERIAL

- Polypropylene (PP)
- Polyethylene (PE)
- Recycled plastic
- Bio plastic



COLORS

- Depending on the material transparent, natural or in various attractive standard colors



ACCESSORIES

- With hanger on request

USABLE LENGTHS

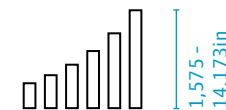

Ø DIAMETER

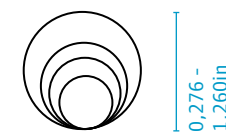

STANDARD COLORS



Product Range

Article	Inner diam.	Usable length (adjustable)	PU
TP 7 050	0.276in	1.969 - 3.543in	3200
TP 7 075	0.276in	2.953 - 4.528in	3200
TP 9 040	0.354in	1.575 - 2.559in	2000
TP 9 065	0.354in	2.559 - 4.331in	2000
TP 12 050	0.472in	1.969 - 3.15in	2900
TP 12 080	0.472in	3.15 - 4.724in	3500
TP 12 120	0.472in	4.724 - 7.874in	2000
TP 12 200	0.472in	7.874 - 14.173in	2100
TP 14 050	0.551in	1.969 - 3.15in	2200
TP 14 080	0.551in	3.15 - 4.724in	2800
TP 14 120	0.551in	4.724 - 7.874in	1600
TP 14 200	0.551in	7.874 - 14.173in	1500
TP 16 050	0.63in	1.969 - 3.15in	1700
TP 16 080	0.63in	3.15 - 4.724in	2000
TP 16 120	0.63in	4.724 - 7.874in	1200
TP 16 200	0.63in	7.874 - 14.173in	1200
TP 18 050	0.709in	1.969 - 3.15in	1500
TP 18 080	0.709in	3.15 - 4.724in	1700
TP 18 120	0.709in	4.724 - 7.874in	1100
TP 18 200	0.709in	7.874 - 14.173in	1000
TP 20 050	0.787in	1.969 - 3.15in	1200
TP 20 080	0.787in	3.15 - 4.724in	1500
TP 20 120	0.787in	4.724 - 7.874in	1000
TP 20 200	0.787in	7.874 - 14.173in	900
TP 22 050	0.866in	1.969 - 3.15in	1000
TP 22 080	0.866in	3.15 - 4.724in	1300
TP 22 120	0.866in	4.724 - 7.874in	800
TP 22 200	0.866in	7.874 - 14.173in	750
TP 24 050	0.945in	1.969 - 3.15in	1900
TP 24 080	0.945in	3.15 - 4.724in	1200
TP 24 120	0.945in	4.724 - 7.874in	800
TP 24 200	0.945in	7.874 - 14.173in	650
TP 26 050	1.024in	1.969 - 3.15in	1700
TP 26 080	1.024in	3.15 - 4.724in	850
TP 26 120	1.024in	4.724 - 7.874in	550
TP 26 200	1.024in	7.874 - 14.173in	500
TP 28 050	1.26in	1.969 - 3.15in	1400
TP 28 080	1.26in	3.15 - 4.724in	800
TP 28 120	1.26in	4.724 - 7.874in	500
TP 28 200	1.26in	7.874 - 14.173in	450
TP 30 050	1.102in	1.969 - 3.15in	1200
TP 30 080	1.102in	3.15 - 4.724in	650
TP 30 120	1.102in	4.724 - 7.874in	400
TP 30 200	1.102in	7.874 - 14.173in	400
TP 32 050	1.181in	1.969 - 3.15in	1000
TP 32 080	1.181in	3.15 - 4.724in	650
TP 32 120	1.181in	4.724 - 7.874in	400
TP 32 200	1.181in	7.874 - 14.173in	350

TopPack

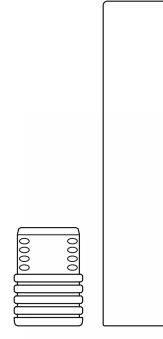

High-quality packaging tubes with short shankholding base-plug or telescopic inner part. Ideal for solid carbide cutters

- attractive design
- high protection for tool cutting edges
- groove in bottom part makes opening easy
- durable and reusable
- telescopic inner parts with ratchet length adjustment
- center adaptor to support and secure tool
- sturdy, oil, and moisture resistant



Simply top – and always the right packaging for optimum protection of your shank tools



PACKAGING

Outer parts and inner parts are packed separately in individual cartons



MATERIAL

- Polyethylene (PE)
- Polypropylene (PP)



COLORS

- Outer part in transparent
- Base plug and inner part in various attractive standard colors



ACCESSORIES

- TopPack Adaptor Cap
- TopPack Center Adaptor
- ProtectiveCap (see page 176)
- Protective Sleeves (see page 184)
- TopPack FiveFrame (see page 188)

USABLE LENGTHS

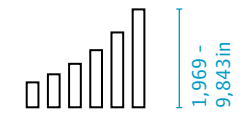

SHANK DIAM.



STANDARD COLORS

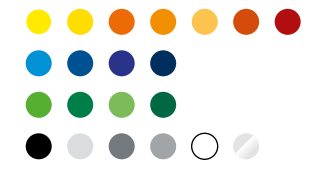

Product Range

Base plug / inner part

Article	Part type	Diameter	Shank diam.	Shank diam. (in.)	Inner length	PU
TPK 8x18-3/1 l	base plug	0.315in	0.118in		0.709in	1000
TPK 8x18-4/1 l	base plug	0.315in	0.157in		0.709in	1000
TPK 8x18-5/1 l	base plug	0.315in	0.197in		0.709in	1000
TPK 8x18-6/1 l	base plug	0.315in	0.236in		0.709in	1000
TPK 8x18-8/1 l	base plug	0.315in	0.315in		0.709in	1000
TPK 8x58/1 l	telescop inner part	0.315in			2.283in	1000
TPK 8x18-1/4"/1 l	base plug	0.315in	0.25in	1/4"	0.709in	1000
TPK 8x18-1/8"/1 l	base plug	0.315in	0.125in	1/8"	0.709in	1000
TPK 8x18-3/16"/1 l	base plug	0.315in	0.187in	3/16"	0.709in	1000
TPK 13x25-3/1 l	base plug	0.512in	0.118in		0.984in	1000
TPK 13x25-4/1 l	base plug	0.512in	0.157in		0.984in	1000
TPK 13x25-5/1 l	base plug	0.512in	0.197in		0.984in	1000
TPK 13x25-6/1 l	base plug	0.512in	0.236in		0.984in	1000
TPK 13x25-7/1 l	base plug	0.512in	0.276in		0.984in	1000
TPK 13x25-8/1 l	base plug	0.512in	0.315in		0.984in	1000
TPK 13x25-10/1 l	base plug	0.512in	0.394in		0.984in	1000
TPK 13x25-12/1 l	base plug	0.512in	0.472in		0.984in	1000
TPK 13x25-9/1 l	base plug	0.512in	0.354in		0.984in	1000
TPK 13x60/1 l	telescop inner part	0.512in			2.362in	500
TPK 13x79/1 l	telescop inner part	0.512in			3.11in	1000
TPK 13x25-1/2"/1 l	base plug	0.512in	0.5in	1/2"	0.984in	1000
TPK 13x25-1/4"/1 l	base plug	0.512in	0.25in	1/4"	0.984in	1000
TPK 13x25-3/8"/1 l	base plug	0.512in	0.375in	3/8"	0.984in	1000
TPK 13x25-7/16"/1 l	base plug	0.512in	0.437in	7/16"	0.984in	1000
TPK 18x34-14/1 l	base plug	0.709in	0.551in		1.339in	500
TPK 18x34-16/1 l	base plug	0.709in	0.63in		1.339in	500
TPK 18x90/1 l	telescop inner part	0.709in			3.543in	500
TPK 18x34-5/8"/1 l	base plug	0.709in	0.625in	5/8"	1.339in	500
TPK 18x34-9/16"/1 l	base plug	0.709in	0.562in	9/16"	1.339in	500
TPK 20x40-18/1 l	base plug	0.827in	0.709in		1.575in	250
TPK 20x40-20/1 l	base plug	0.827in	0.787in		1.575in	250
TPK 20x91/1 l	telescop inner part	0.827in			3.583in	500
TPK 20x40-3/4"/1 l	base plug	0.827in	0.75in	3/4"	1.575in	250
TPK 26x136/1 l	telescop inner part	1.024in			5.354in	300
TPK 32x155/1 l	telescop inner part	1.26in			6.102in	150

Product Range

Outer part

Article	Part type	Diam.	Inner length	Suitable inner part	Usable length	PU
TPK 8x42 A	outer part	0.315in	1.654in	TPK 8 base plug	1.97in	1000
				TPK 8x58/1 I telescop inner part	2.28-3.54in	1000
TPK 8x52 A	outer part	0.315in	2.047in	TPK 8 base plug	2.36in	1000
				TPK 8x58/1 I telescop inner part	2.36-3.94in	1000
TPK 8x70 A	outer part	0.315in	2.756in	TPK 8 base plug	3.03in	1000
				TPK 8x58/1 I telescop inner part	3.03-4.65in	1000
TPK 8x85/2 A*	outer part	0.315in	3.346in	TPK 8 base plug	3.62in	2300
TPK 8x97 A	outer part	0.315in	3.819in	TPK 8 base plug	4.13in	1000
				TPK 8x97/1 I telescop inner part	4.13-5.31in	1000
TPK 8x97/2 A*	outer part	0.315in	3.819in	TPK 8 base plug	4.13in	1000
TPK 13x56 A	outer part	0.512in	2.205in	TPK 13 base plug	2.60in	500
				TPK 13x60/1 I telescop inner part	2.60-3.94in	500
				TPK 13x79/1 I telescop inner part	3.11-4.69in	500
				TPK 13x60/1 I telescop inner part	3.31-4.69in	500
TPK 13x74 A	outer part	0.512in	2.913in	TPK 13 base plug	3.31in	500
				TPK 13x60/1 I telescop inner part	3.31-4.69in	500
				TPK 13x79/1 I telescop inner part	3.31-5.43in	500
				TPK 13x60/1 I telescop inner part	3.86-5.18in	500
TPK 13x88 A	outer part	0.512in	3.465in	TPK 13 base plug	3.86in	500
				TPK 13x60/1 I telescop inner part	3.86-5.18in	500
				TPK 13x79/1 I telescop inner part	3.86-5.93in	500
				TPK 13x60/1 I telescop inner part	4.25-5.59in	500
TPK 13x97 A	outer part	0.512in	3.819in	TPK 13 base plug	4.25in	500
				TPK 13x60/1 I telescop inner part	4.25-5.59in	500
				TPK 13x79/1 I telescop inner part	4.25-6.34in	500
				TPK 13x60/1 I telescop inner part	4.72-6.10in	500
TPK 13x110 A	outer part	0.512in	4.331in	TPK 13 base plug	4.72in	500
				TPK 13x60/1 I telescop inner part	4.72-6.10in	500
				TPK 13x79/1 I telescop inner part	4.72-6.85in	500
				TPK 13x60/1 I telescop inner part	4.72-6.85in	500
TPK 18x83 A	outer part	0.709in	3.268in	TPK 18 base plug	3.86in	500
				TPK 18x90/1 I telescop inner part	3.86-6.06in	500
TPK 18x113 A	outer part	0.709in	4.449in	TPK 18 base plug	5.08in	500
				TPK 18x90/1 I telescop inner part	5.08-7.42in	500
TPK 18x130 A	outer part	0.709in	5.118in	TPK 18 base plug	5.67in	250
				TPK 18x90/1 I telescop inner part	5.67-7.87in	250
TPK 18x145/2 A*	outer part	0.709in	5.709in	TPK 18 base plug	6.22in	500
TPK 20x89 A	outer part	0.787in	3.504in	TPK 20 base plug	4.25in	250
				TPK 20x91/1 I telescop inner part	4.25-6.06in	250
TPK 20x130 A	outer part	0.787in	5.118in	TPK 20 base plug	5.86in	250
				TPK 20x91/1 I telescop inner part	5.87-7.68in	250
TPK 26x124 A	outer part	1.024in	4.882in	TPK 26x136/1 I telescop inner part	5.71-8.66in	300
TPK 32x145 A	outer part	1.26in	5.709in	TPK 32x155/1 I telescop inner part	6.69-9.84in	150

*Outer part made of PVC

Accessories for telescop inner part

Article	Part type	Suitable for	Shank diam.	PU	Article	Part type	Suitable for	Shank diam.	PU
TKA 8-3/4	adaptor cap	TPK Ø 8	3-5mm	1000	TKA 8-3/3	center adaptor	TPK Ø 8	3-5mm	1000
TKA 13-3/4	adaptor cap	TPK Ø 13	3-6mm	1000	TKA 13-3/3	center adaptor	TPK Ø 13	3-6mm	1000
TKA 13-6/4	adaptor cap	TPK Ø 13	6-8mm	1000	TKA 13-6/3	center adaptor	TPK Ø 13	6-8mm	1000
TKA 18-8/4	adaptor cap	TPK Ø 18	8-14mm	1000	TKA 18-8/3	center adaptor	TPK Ø 18	8-14mm	1000
TKA 20-10/4	adaptor cap	TPK Ø 20	10-16mm	500	TKA 20-10/3	center adaptor	TPK Ø 20	10-16mm	500
TKA 26-16/4	adaptor cap	TPK Ø 26	16-22mm	300	TKA 26-16/3	center adaptor	TPK Ø 26	16-22mm	300
TKA 32-20/4	adaptor cap	TPK Ø 32	20-28mm	300	TKA 32-20/3	center adaptor	TPK Ø 32	20-28mm	300



PACKAGING

Outer parts and inner parts are packed separately in individual cartons



MATERIAL

- Polyethylene (PE)
- Polypropylene (PP)



COLORS

- Outer part in transparent
- Base plug and inner part in various attractive standard colors



ACCESSORIES

- TopPack Adaptor Cap
- TopPack Center Adaptor
- ProtectiveCap (see page 176)
- Protective Sleeves (see page 184)
- TopPack FiveFrame (see page 188)

USABLE LENGTHS

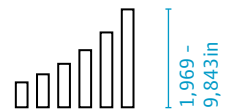

SHANK DIAM.

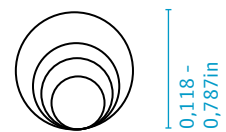

STANDARD COLORS



Good to know

Top tool protection with TopPack. It's so easy.

Effective and simple: perfect protection for your shank tools – with TopPack from rose plastic and our well-thought-out accessories.

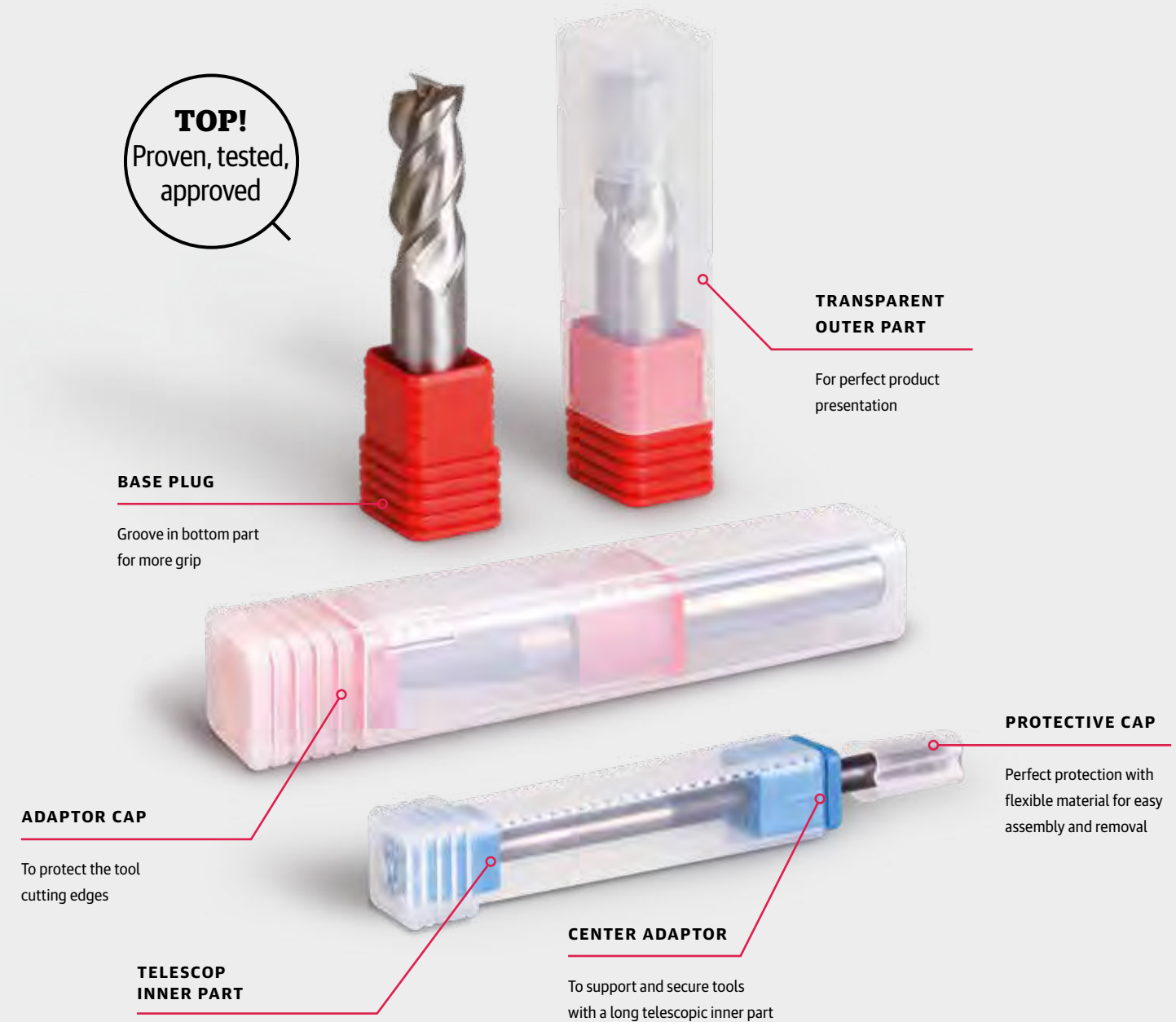

TOP!
Proven, tested, approved

TRANSPARENT OUTER PART

For perfect product presentation

BASE PLUG

Groove in bottom part for more grip

PROTECTIVE CAP

Perfect protection with flexible material for easy assembly and removal

ADAPTOR CAP

To protect the tool cutting edges

CENTER ADAPTOR

To support and secure tools with a long telescopic inner part

TELESCOP INNER PART

Variable length adjustment with ratchet mechanism for long telescopic inner part

TopPackConical

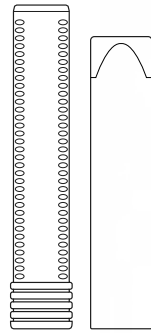

Plastic packaging tubes for solid carbide cutters and solid carbide drills

- universal application for tools with different dimensions due to ratchet length adjustment
- in TopPack inner and outer tubes, shank tools, milling cutters, and drills are centrally positioned in the pack – regardless of tool diameter
- delicate cutting edges are protected by the internal conical ribs
- grooves in bases provide good grip for easy opening
- durable and reusable
- sturdy, oil, and moisture resistant



No need for height control – the perfect packaging tube for tools with different dimensions thanks to flexible length adjustment



PACKAGING

Outer parts and inner parts are packed separately in individual cartons



MATERIAL

- Polypropylene (PP)



COLORS

- PP transparent or in various attractive standard colors

USABLE LENGTHS

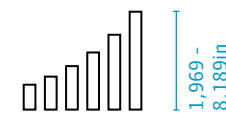

SHANK DIAM.

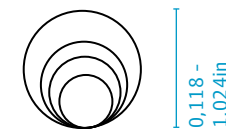

STANDARD COLORS



Product Range

Article	Part type	Shank diam.	Inner length	Suitable Inner part	Usable length*	PU
TPKZR 8x42 A	outer part	1.18-3.15in	1.654in	TPKZR 8x38 /1 I TPKZR 8x58 /1 I	1.97-2.64in 2.36-3.19in	1000
TPKZR 8x52 A	outer part	1.18-3.15in	2.047in	TPKZR 8x38 /1 I TPKZR 8x58 /1 I	2.28-3.03in 2.36-3.58in	1000
TPKZR 8x70 A	outer part	1.18-3.15in	2.756in	TPKZR 8x38 /1 I TPKZR 8x58 /1 I	2.99-3.74in 2.83-4.29in	1000
TPKZR 8x38/1 I	inner part	1.18-3.15in	1.496in			1000
TPKZR 8x58/1 I	inner part	1.18-3.15in	2.283in			1000
TPKZR 13x56 A	outer part	2.36-5.12in	2.205in	TPKZR 13x60 /1 I TPKZR 13x79 /1 I	2.44-3.43in 3.23-4.61in	500
TPKZR 13x74 A	outer part	2.36-5.12in	2.913in	TPKZR 13x60 /1 I TPKZR 13x79 /1 I	2.99-4.13in 3.23-4.92in	1000
TPKZR 13x97 A	outer part	2.36-5.12in	3.819in	TPKZR 13x60 /1 I TPKZR 13x79 /1 I	3.94-5.12in 3.94-5.91in	500
TPKZR 13x60/1 I	inner part	2.36-5.12in	2.362in			500
TPKZR 13x79/1 I	inner part	2.36-5.12in	3.11in			1000
TPKZR 18x45 A	outer part	5.51-7.09in	1.772in	TPKZR 18x47 /1 I TPKZR 18x61 /1 I	2.01-2.83in 2.72-3.39in	500
TPKZR 18x63 A	outer part	5.51-7.09in	2.48in	TPKZR 18x61 /1 I	2.72-3.94in	500
TPKZR 18x83 A	outer part	5.51-7.09in	3.268in	TPKZR 18x90 /1 I	3.94-5.83in	500
TPKZR 18x47/1 I	inner part	5.51-7.09in	41.85in			500
TPKZR 18x61/1 I	inner part	5.51-7.09in	2.402in			500
TPKZR 18x90/1 I	inner part	5.51-7.09in	3.543in			500
TPKZR 20x62 A	outer part	5.51-7.87in	2.441in	TPKZR 20x70 /1 I	2.95-4.02in	250
TPKZR 20x89 A	outer part	5.51-7.87in	83.504in	TPKZR 20x91 /1 I	4.06-6.10in	250
TPKZR 20x70/1 I	inner part	5.51-7.87in	2.756in			250
TPKZR 20x91/1 I	inner part	5.51-7.87in	3.583in			250
TPKZR 26x82 A	outer part	7.87-10.24in	3.228in	TPKZR 26x90 /1 I TPKZR 26x136 /1 I	3.94-5.43in 5.43-7.24in	300
TPKZR 26x124 A	outer part	7.87-10.24in	4.882in	TPKZR 26x90 /1 I TPKZR 26x136 /1 I	5.43-7.09in 5.43-8.19in	300
TPKZR 26x90/1 I	inner part	7.87-10.24in	3.543in			300
TPKZR 26x136/1 I	inner part	7.87-10.24in	5.354in			300

*The usable lengths are mean values and may vary depending on the tool diameter.

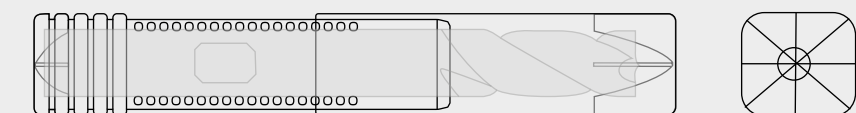

TopPack Foldback

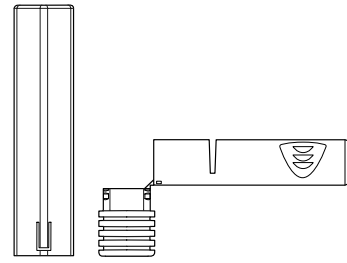

Plastic packaging tubes with ,PLUS' clamping device for optimum protection of micro tools

- encapsulated fold back design and outer cover provides optimum protection for delicate tools
- easy loading and unloading due to the fold back design
- tight fit of tool provided by shank clamping device in the back part; also available: "PLUS" clamping device for highly polished and smooth tool shanks
- durable hinge design creates reusability of the package
- coding by different color versions of the "PLUS" clamping device possible
- incorporated grooves provide grip for easy opening
- outer parts are transparent for product identification
- sturdy, oil, and moisture resistant



Perfectly wrapped – safely packed. Excellent protection for sensitive tool tips



PACKAGING

Outer parts and inner parts are packed separately in individual cartons



MATERIAL

- Inner part: Polypropylene (PP)
- Inner part with "PLUS" clamping device: Polypropylen (PP) with TPE
- Outer part: Polypropylene (PP)



COLORS

- Outer part in transparent
- Inner part in transparent or in various attractive standard colors
- PLUS clamping device in red, blue and natural; further colors and color combinations on request



ACCESSORIES

- TopPack FiveFrame (see page 188)

USABLE LENGTHS

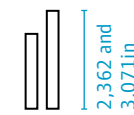

SHANK DIAM.

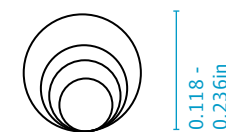

STANDARD COLORS



Product Range

Inner part

Article	Part type	Diameter	Shank diam.	PU
TPKFO 8-3 I	inner part	0.315in	0.118in	1000
TPKFO 8-3.175 I	inner part	0.315in	0.125in	1000
TPKFO 8-4 I	inner part	0.315in	0.157in	1000
TPKFO 8-5 I	inner part	0.315in	0.197in	1000
TPKFO 8-6 I	inner part	0.315in	0.236in	1000
TPKFO 8-3 PLUS/2 I	inner part w/ PLUS clamping	0.315in	0.118in	1000
TPKFO 8-3.175 PLUS I	inner part w/ PLUS clamping	0.315in	0.125in	1000
TPKFO 8-4 PLUS/2 I	inner part w/ PLUS clamping	0.315in	0.157in	1000
TPKFO 8-5 PLUS I	inner part w/ PLUS clamping	0.315in	0.197in	1000
TPKFO 8-6 PLUS/2 I	inner part w/ PLUS clamping	0.315in	0.236in	1000

Outer part

Article	Part type	Diameter	Inner length	Usable length	PU
TPK 8x52 A	outer part	0.315in	2.047in	2,362in	1000
TPK 8x70 A	outer part	0.315in	2.756in	3,071in	1000

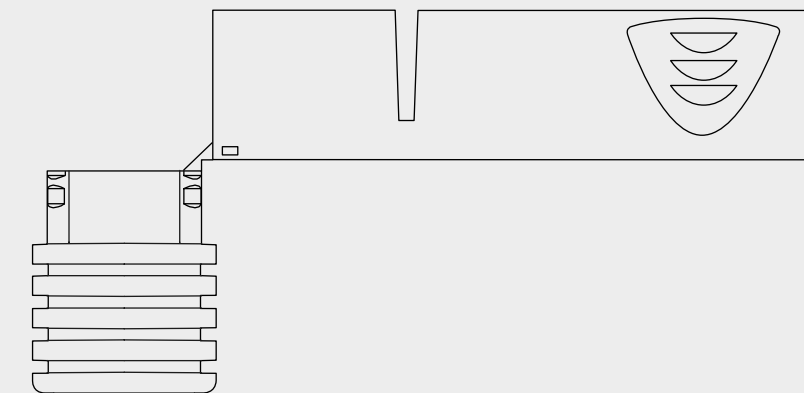

TopPackWing

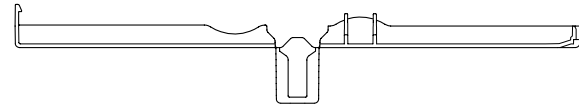

One-piece plastic packaging tubes for solid carbide shank tools

- total protection for delicate tool tips due to complete coverage
- simple handling due to the hinged 'wings'
- easy loading/unloading due to the hinge design
- additional support through integral shankholding fixings
- durable and reusable
- sturdy, oil, and moisture resistant



PACKAGING

Carton



MATERIAL

- Polypropylene (PP)



COLORS

- PP transparent or in various attractive standard colors

USABLE LENGTHS

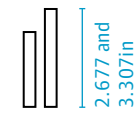

Ø DIAMETER

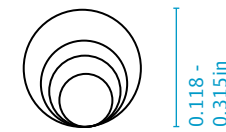

STANDARD COLORS

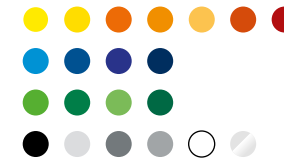

Product Range

Article	Diameter	Shank diam.	Usable length fixed	PU
TPKW 8x68-3/1	0.315in	0.118in	2.677in	1000
TPKW 8x68-3.175/1	0.315in	0.125in	2.677in	1000
TPKW 8x68-4/1	0.315in	0.157in	2.677in	1000
TPKW 8x68-5/1	0.315in	0.197in	2.677in	1000
TPKW 8x68-6/1	0.315in	0.236in	2.677in	1000
TPKW 8x68-8/1	0.315in	0.315in	2.677in	1000
TPKW 8x84-3/1	0.315in	0.118in	3.307in	1000
TPKW 8x84-3.175/1	0.315in	0.125in	3.307in	1000
TPKW 8x84-4/1	0.315in	0.157in	3.307in	1000
TPKW 8x84-5/1	0.315in	0.197in	3.307in	1000
TPKW 8x84-6/1	0.315in	0.236in	3.307in	1000
TPKW 8x84-8/1	0.315in	0.315in	3.307in	1000



Protective shell – the ideal packaging solution for micro drills and precision tools

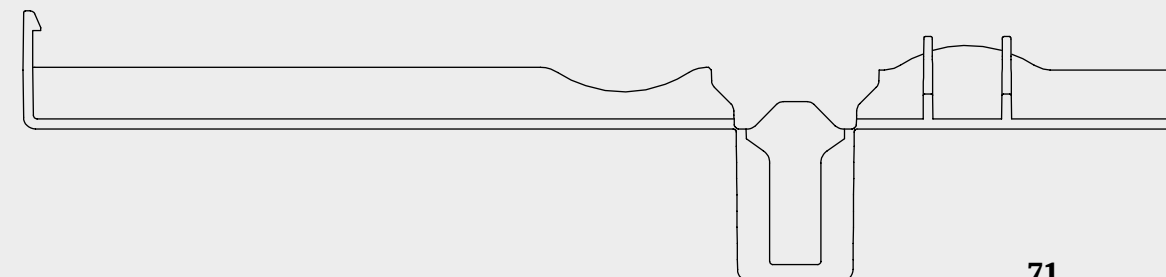

TopPackXLine

Plastic packaging tubes for extra long solid carbide drills

- patented shankholding system and longer plug size offer optimum fit
- ergonomic shape plus incorporated grooves provide grip for easy opening
- reclosable and reusable
- attractive design
- optimum visibility of content
- sturdy, oil, and moisture resistant

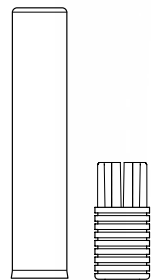

Always one length ahead – the packaging tube with a longer plug size for extra-long drills

=CONVERT(A2, "mm", "in")



PACKAGING

Outer parts and inner parts are packed separately in individual cartons



MATERIAL

- Outer part: PVC
- Base plug: Polyethylene (PE)
- Middle part: PVC
- Middle part adapter: Polypropylene (PP)



COLORS

- Outer part and middle part in clear, base plug and middle part adapter in a variety of attractive standard colors



ACCESSORIES

- TopPack Adaptor cap
- ProtectivCap (see page 176)

USABLE LENGTHS

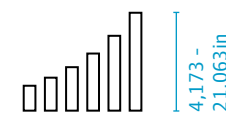

SHANK DIAM.



STANDARD COLORS



Product Range

Article	Part type	Dia- meter	Shank diam.	Inner length	PU	Article	Part type	Dia- meter	Shank diam.	Inner length	PU
TPKXL 13x40-3/1 I	base plug	0.512in	0.118in	1.575in	1000	TPKXL 18x50-10/1 I	base plug	0.709in	0.394in	1.969in	1000
TPKXL 13x40-4/1 I	base plug	0.512in	0.157in	1.575in	1000	TPKXL 18x50-11/1 I	base plug	0.709in	0.433in	1.969in	1000
TPKXL 13x40-5/1 I	base plug	0.512in	0.197in	1.575in	1000	TPKXL 18x50-12/1 I	base plug	0.709in	0.472in	1.969in	1000
TPKXL 13x40-6/1 I	base plug	0.512in	0.236in	1.575in	1000	TPKXL 18x50-13/1 I	base plug	0.709in	0.512in	1.969in	1000
TPKXL 13x40-7/1 I	base plug	0.512in	0.276in	1.575in	1000	TPKXL 18x50-14/1 I	base plug	0.709in	0.551in	1.969in	1000
TPKXL 13x40-8/1 I	base plug	0.512in	0.315in	1.575in	1000	TPKXL 18x50-16/1 I	base plug	1.024in	0.63in	1.969in	1000
TPKXL 18x50-6/1 I	base plug	0.709in	0.236in	1.969in	1000	TPKXL 26x50-16/1 I	base plug	1.024in	0.709in	1.969in	1000
TPKXL 18x50-8/1 I	base plug	0.709in	0.315in	1.969in	1000	TPKXL 26x50-18/1 I	base plug	1.024in	0.787in	1.969in	1000
TPKXL 18x50-9/1 I	base plug	0.709in	0.354in	1.969in	1000	TPKXL 26x50-20/1 I	base plug	1.024in	0.787in	1.969in	1000

Article	Part type	Ø	Inner length	Suitable base plug / middle part	Usable length	PU
TPKXL 13x108 A	outer part	0.512in	4.252in	TPKXL 13x40	4.17in / 4.41in / 4.92in	340
TPKXL 13x140 A	outer part	0.512in	5.512in	TPKXL 13x40	5.43in / 5.67in / 6.18in	340
TPKXL 13x168 A	outer part	0.512in	6.614in	TPKXL 13x40	6.54in / 6.77in / 7.28in	340
TPKXL 13x180 A	outer part	0.512in	7.087in	TPKXL 13x40	7.01in / 7.24in / 7.76in	340
TPKXL 13x205 A	outer part	0.512in	8.071in	TPKXL 13x40	7.99in / 8.15in / 8.74in	340
TPKXL 13x238 A	outer part	0.512in	9.37in	TPKXL 13x40	9.29in / 9.45in / 10.04in	340
TPKXL 13x260 A	outer part	0.512in	10.236in	TPKXL 13x40	10.16in / 10.32in / 10.91in	340
TPKXL 13x338 A	outer part	0.512in	13.307in	TPKXL 13x40	13.19in / 13.39in / 13.98in	340
TPKXL 18x160 A	outer part	0.709in	6.30in	TPKXL 18x50	7.24 in	340
	middle part	0.709in	5.709in	TPKXL 18x145 M	13.23 in	360
	middle part	0.709in	7.874in	TPKXL 18x200 M	15.39 in	270
	middle part	0.709in	11.221in	TPKXL 18x285 M	18.74 in	270
	middle part	0.709in	16.142in	TPKXL 18x410 M	23.70 in	220
TPKXL 18x186 A	outer part	0.709in	7.323in	TPKXL 18x50	8.27 in	340
	middle part	0.709in	5.709in	TPKXL 18x145 M	14.25 in	360
	middle part	0.709in	7.874in	TPKXL 18x200 M	16.42 in	270
	middle part	0.709in	11.221in	TPKXL 18x285 M	19.76 in	270
	middle part	0.709in	16.142in	TPKXL 18x410 M	24.69 in	220
TPKXL 18x215 A	outer part	0.709in	8.464in	TPKXL 18x50	9.41 in	340
	middle part	0.709in	7.874in	TPKXL 18x200 M	17.57 in	270
	middle part	0.709in	11.221in	TPKXL 18x285 M	20.91 in	270
	middle part	0.709in	16.142in	TPKXL 18x410 M	25.79 in	220
TPKXL 18x243 A	outer part	0.709in	9.567in	TPKXL 18x50	10.51 in	267
TPKXL 18x271 A	outer part	0.709in	10.67in	TPKXL 18x50	11.61 in	340
	middle part	0.709in	11.221in	TPKXL 18x285 M	23.12 in	270
	middle part	0.709in	16.142in	TPKXL 18x410 M	28.03 in	220
TPKXL 18x331 A	outer part	0.709in	13.032in	TPKXL 18x50	13.98 in	340
	middle part	0.709in	16.142in	TPKXL 18x410 M	30.39 in	220
TPKXL 18x431 A	outer part	0.709in	16.969in	TPKXL 18x50	17.91 in	340
TPKXL 18x431/2 A*	outer part	0.709in	16.969in	TPKXL 18x50	17.91 in	340
TPKXL 18x511 A	outer part	0.709in	20.118in	TPKXL 18x50	21.06 in	85
TPKXL 26x96 A	outer part	1.024in	3.78in	TPKXL 26x50	4.76in	340
TPKXL 26x136 A	outer part	1.024in	5.354in	TPKXL 26x50	6.34in	170
TPKXL 26x190 A	outer part	1.024in	7.480in	TPKXL 26x50	8.465in	170
TPKXL 26x226 A	outer part	1.024in	8.898in	TPKXL 26x50	9.88in	170
TPKXL 26x240 A	outer part	1.024in	9.449in	TPKXL 26x50	10.433in	170
TPKXL 26x291 A	outer part	1.024in	11.457in	TPKXL 26x50	12.44in	85

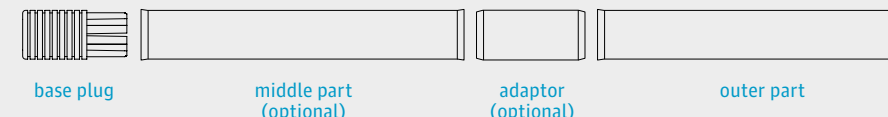

*Outer part with indentation for fixing the tools

TopPack XPress

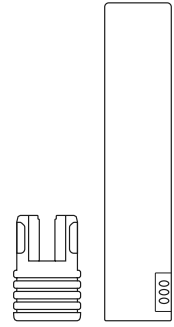

High quality single piece packaging with XPress shank-holding system. Ideal for precision shank tools such as solid carbide cutters and drills

- XPress plug design for simple and secure loading/removal of tool
- diagonally arranged clamping webs in the mounting base ensure perfect hold
- user-friendly function ensures easier and safer handling of sensitive and sharp-edged cutting tools
- grooves in side of plug assist easy opening/closing
- used in conjunction with end caps increases tool holding and gives extra protection of delicate tools
- outers click securely into place with ratchet mechanism
- durable and reusable
- sturdy, oil, and moisture resistant



A secure grip with an attractive design – to ensure precision shank tools are optimally protected



PACKAGING

Outer parts and inner parts are packed separately in individual cartons



MATERIAL

- Outer part: Polypropylene (PP)
- Base plug: Polyethylene (PE)



COLORS

- Outer part in transparent
- Base plug in various attractive standard colors



ACCESSORIES

- TopPack Adaptor Cap
- ProtectiveCap (see page 176)
- Protective Sleeves (see page 184)
- TopPack FiveFrame (see page 188)

USABLE LENGTHS

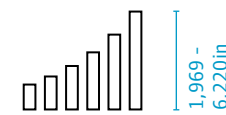

SHANK DIAM.

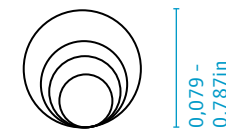

STANDARD COLORS



Product Range

Base plug

Article	Part type	Diam.	Shank diam.	Shank diam. (in.)	Inner length	PU
TPKXP 8x18-2/1 I	base plug	0.315in	0.079in		0.709in	1000
TPKXP 8x18-2.35/1 I	base plug	0.315in	0.093in		0.709in	1000
TPKXP 8x18-1/4"/1 I	base plug	0.315in	0.25in	1/4"	0.709in	1000
TPKXP 8x18-3/1 I	base plug	0.315in	0.118in		0.709in	1000
TPKXP 8x18-1/8"/1 I	base plug	0.315in	0.125in	1/8"	0.709in	1000
TPKXP 8x18-4/1 I	base plug	0.315in	0.157in		0.709in	1000
TPKXP 8x18-3/16"/1 I	base plug	0.315in	0.187in	3/16"	0.709in	1000
TPKXP 8x18-5/1 I	base plug	0.315in	0.197in		0.709in	1000
TPKXP 8x18-6/1 I	base plug	0.315in	0.236in		0.709in	1000
TPKXP 8x18-7/1 I	base plug	0.315in	0.276in		0.709in	1000
TPKXP 8x18-8/1 I	base plug	0.315in	0.315in		0.709in	1000
TPKXP 13x25-2.35/1 I	base plug	0.512in	0.093in		0.984in	1000
TPKXP 13x25-1/2"/1 I	base plug	0.512in	0.5in	1/2"	0.984in	1000
TPKXP 13x25-1/4"/1 I	base plug	0.512in	0.25in	1/4"	0.984in	1000
TPKXP 13x25-1/4 "/1 I	base plug	0.512in	0.25in	1/4"	0.984in	1000
TPKXP 13x25-3/1 I	base plug	0.512in	0.118in		0.984in	1000
TPKXP 13x25-4/1 I	base plug	0.512in	0.157in		0.984in	1000
TPKXP 13x25-5/1 I	base plug	0.512in	0.197in		0.984in	1000
TPKXP 13x25-6/1 I	base plug	0.512in	0.236in		0.984in	1000
TPKXP 13x25-7/1 I	base plug	0.512in	0.276in		0.984in	1000
TPKXP 13x25-8/1 I	base plug	0.512in	0.315in		0.984in	1000
TPKXP 13x25-9/1 I	base plug	0.512in	0.354in		0.984in	1000
TPKXP 13x25-3/8"/1 I	base plug	0.512in	0.375in	3/8"	0.984in	1000
TPKXP 13x25-10/1 I	base plug	0.512in	0.394in		0.984in	1000
TPKXP 13x25-7/16"/1 I	base plug	0.512in	0.437in	7/16"	0.984in	1000
TPKXP 13x25-12/1 I	base plug	0.512in	0.472in		0.984in	1000
TPKXP 18x34-16/1 I	base plug	0.709in	0.63in		1.339in	250
TPKXP 18x34-9/1 I	base plug	0.709in	0.354in		1.339in	250
TPKXP 18x34-12/1 I	base plug	0.709in	0.472in		1.339in	250
TPKXP 18x34-14/1 I	base plug	0.709in	0.551in		1.339in	250
TPKXP 18x34-9/16"/1 I	base plug	0.709in	0.562in	9/16"	1.339in	250
TPKXP 18x34-5/8"/1 I	base plug	0.709in	0.625in	5/8"	1.339in	250
TPKXP 20x40-3/4"/1 I	base plug	0.787in	0.75in	3/4"	1.575in	250
TPKXP 20x40-18/1 I	base plug	0.787in	0.709in		1.575in	250
TPKXP 20x40-20/1 I	base plug	0.787in	0.787in		1.575in	250

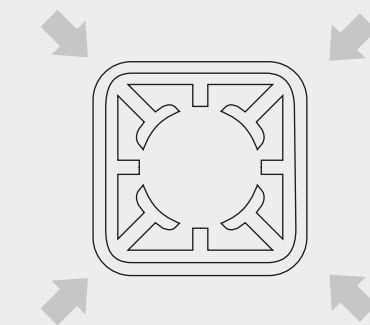

Base plug

Product Range



PACKAGING

Outer parts and inner parts are packed separately in individual cartons



MATERIAL

- Outer part: Polypropylene (PP)
- Base plug: Polyethylene (PE)



COLORS

- Outer part in transparent
- Base plug in various attractive standard colors



ACCESSORIES

- TopPack Adaptor Cap
- ProtectiveCap (see page 176)
- Protective Sleeves (see page 184)
- TopPack FiveFrame (see page 188)

USABLE LENGTHS

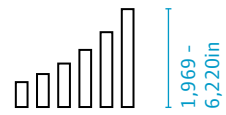

SHANK DIAM.

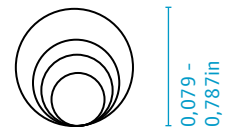

STANDARD COLORS



Outer part

Article	Part type	Diameter	Inner length	Suitable base plug	Usable length	PU
TPK 8x42 A	outer part	0.315in	1.654in	TPKXP 8	1.97in	1000
TPK 8x52 A	outer part	0.315in	2.047in	TPKXP 8	2.36in	1000
TPK 8x70 A	outer part	0.315in	2.756in	TPKXP 8	3.07in	1000
TPK 8x85/2 A*	outer part	0.315in	3.346in	TPKXP 8	3.62in	2300
TPK 8x97 A	outer part	0.315in	3.819in	TPKXP 8	4.13in	1000
TPK 8x97/2 A*	outer part	0.315in	3.819in	TPKXP 8	4.13in	1000
TPK 13x56 A	outer part	0.512in	2.205in	TPKXP 13	2.60in	500
TPK 13x74 A	outer part	0.512in	2.913in	TPKXP 13	3.31in	500
TPK 13x88 A	outer part	0.512in	3.465in	TPKXP 13	3.86in	500
TPK 13x97 A	outer part	0.512in	3.819in	TPKXP 13	4.25in	500
TPK 13x110 A	outer part	0.512in	4.331in	TPKXP 13	4.72in	500
TPK 18x83 A	outer part	0.709in	3.268in	TPKXP 18	3.86in	500
TPK 18x113 A	outer part	0.709in	4.449in	TPKXP 18	5.08in	500
TPK 18x130 A	outer part	0.709in	5.118in	TPKXP 18	5.67in	250
TPK 18x145/2 A*	outer part	0.709in	5.709in	TPKXP 18	6.22in	500
TPK 20x89 A	outer part	0.787in	3.504in	TPKXP 20	4.25in	250
TPK 20x130 A	outer part	0.787in	5.118in	TPKXP 20	5.87in	250

* Outer part in PVC

Accessories

Article	Part type	Suitable for	Shank diam.	PU
TKA 8-3/4	adaptor cap	TPK Ø 8	0.118 - 0.197in	1000
TKA 13-3/4	adaptor cap	TPK Ø 13	0.118 - 0.236in	1000
TKA 13-6/4	adaptor cap	TPK Ø 13	0.236 - 0.315in	1000
TKA 18-8/4	adaptor cap	TPK Ø 18	0.315 - 0.551in	1000
TKA 20-10/4	adaptor cap	TPK Ø 20	0.394 - 0.63in	500
TKA 26-16/4	adaptor cap	TPK Ø 26	0.63 - 0.866in	300
TKA 32-20/4	adaptor cap	TPK Ø 32	0.787 - 1.102in	300

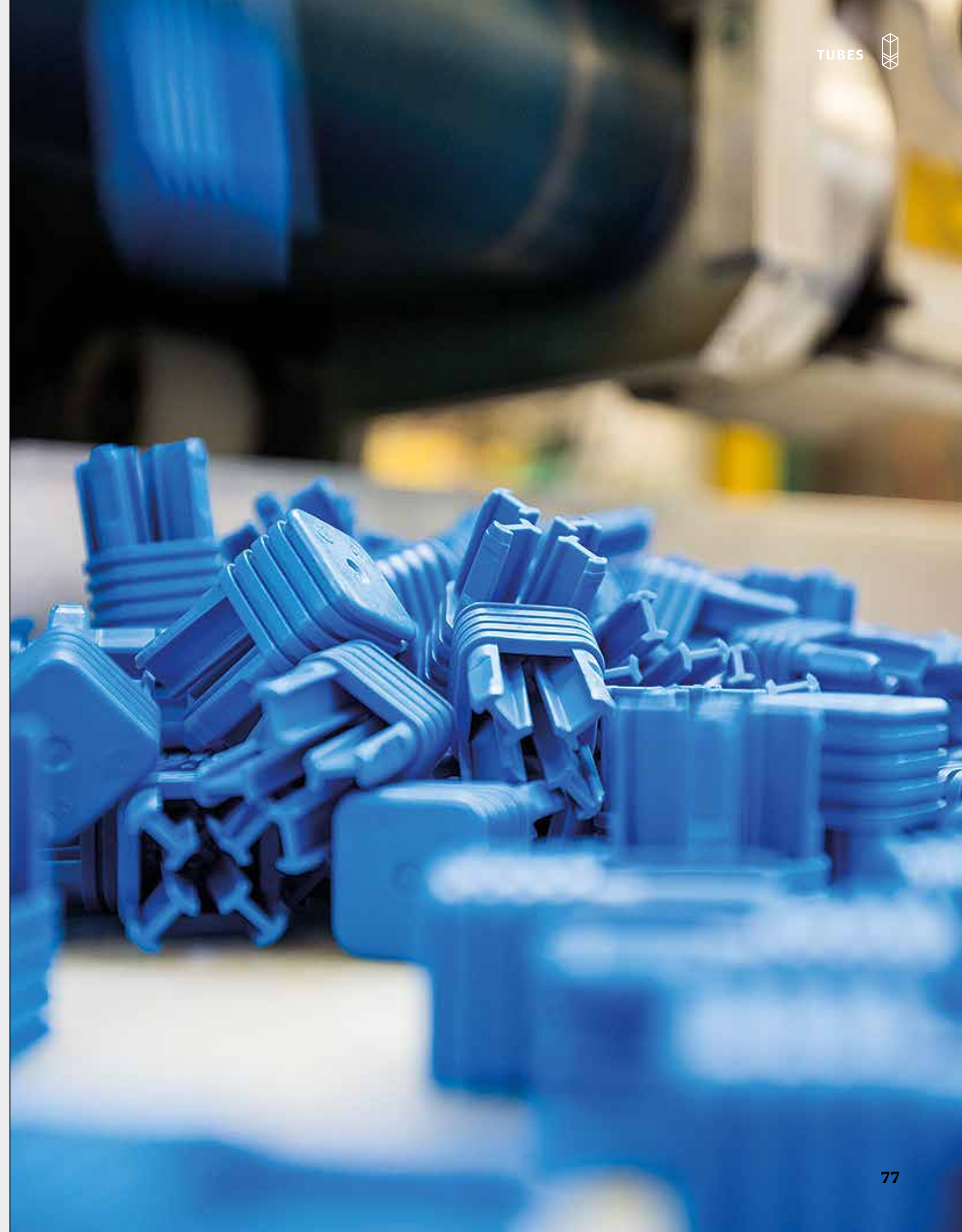



TwistPack Plus

The ultimate plastic packaging tube is here

The TwistPack Plus is the new generation of TwistPack from rose plastic – probably the most used packaging tube in the world.

The TwistPack Plus from rose plastic – even more capable, even simpler, even greater protection.

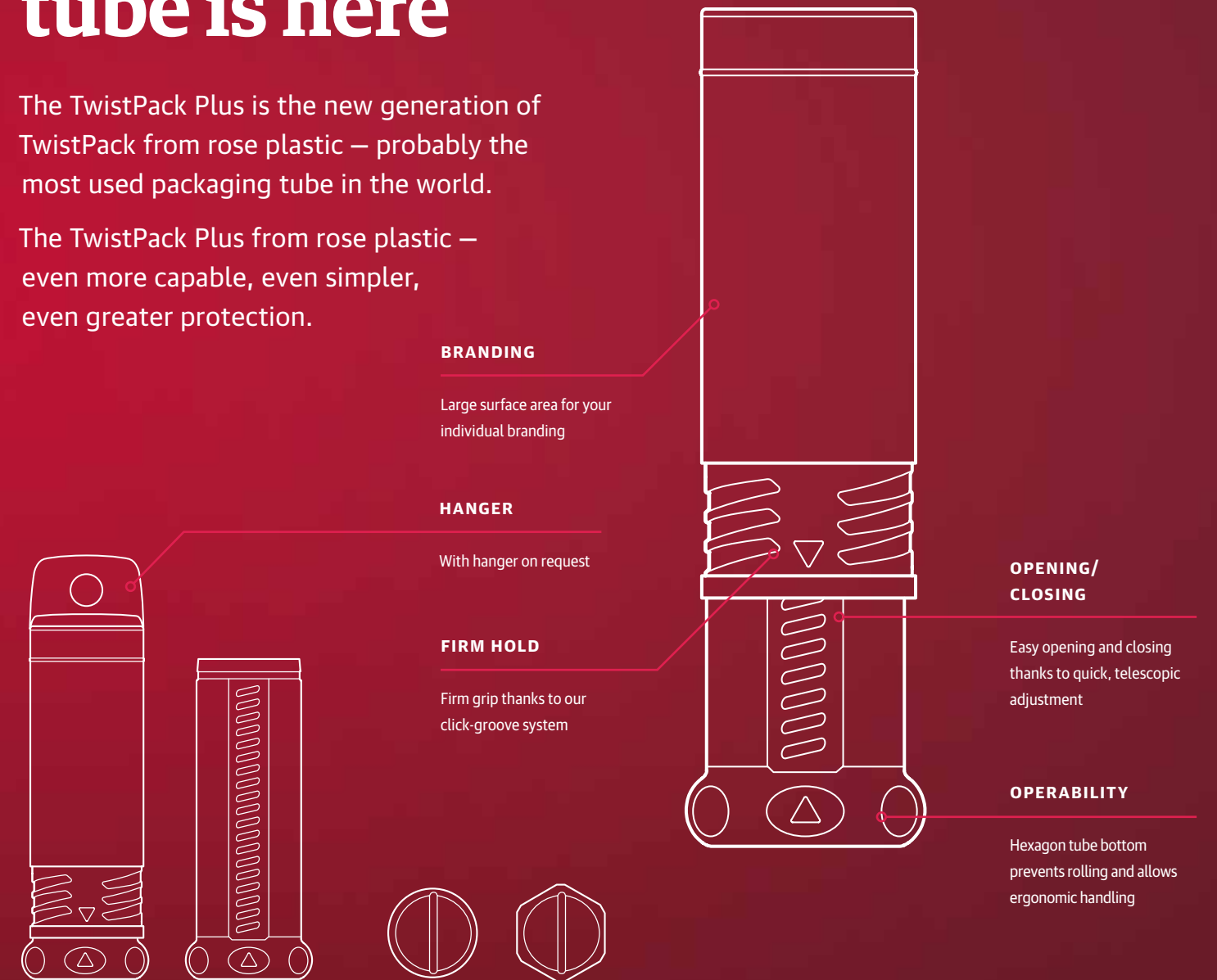



TwistPackPlus

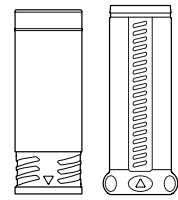

More safety. More efficiency. The new generation of TwistPack packaging tubes convince with user-friendly twist lock closure

- maximum flexibility through universal length adjustment
- optimal product protection
- easy opening and closing through telescopic adjustment
- firm hold force through our click groove system
- large surface area for your individual branding
- hexagon tube bottom prevents rolling
- durable and reusable
- sturdy, oil, and moisture resistant



Need packaging for elongated or cylindrical products? Meet the solution. Simply adjust the length, turn – et voila!



PACKAGING

Outer parts and inner parts are packed separately in individual cartons; TX 85 and TX 105 outer parts and inner parts are packed assembled



MATERIAL

- Polyethylene (PE)
- Polypropylene (PP)
- Polyvinylchloride (PVC)
- Recycled plastic
- Bio plastic



COLORS

- Depending on the material transparent, natural or in various attractive standard colors or two-color



ACCESSORIES

- Foam inserts (see page 180)
- With hanger on request

USABLE LENGTHS

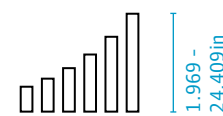

Ø DIAMETER

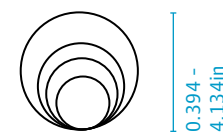

STANDARD COLORS



Product Range

Article	Inner diam.	Usable length	PU	Article	Inner diam.	Usable length	PU
TX 10 050	0.394in	1.969 - 2.756in	2000	TX 35 050	1.378in	1.969 - 2.362in	450
TX 10 080	0.394in	3.15 - 4.724in	1700	TX 35 060	1.378in	2.362 - 3.15in	600
TX 10 120	0.394in	4.724 - 7.874in	1000	TX 35 080	1.378in	3.15 - 4.724in	550
TX 13 050	0.512in	1.969 - 2.756in	2100	TX 35 120	1.378in	4.724 - 7.874in	350
TX 13 080	0.512in	3.15 - 4.724in	1300	TX 35 200	1.378in	7.874 - 13.78in	250
TX 13 120	0.512in	4.724 - 7.874in	1700	TX 35 350	1.378in	13.78 - 24.409in	150
TX 13 200	0.512in	7.874 - 13.78in	1350	TX 35 500*	1.378in	19.685 - 29.528in	250
TX 16 050	0.63in	1.969 - 2.756in	1500	TX 35 700*	1.378in	27.559 - 41.339in	150
TX 16 080	0.63in	3.15 - 4.724in	2000	TX 40 050	1.575in	1.969 - 2.362in	700
TX 16 120	0.63in	4.724 - 7.874in	1200	TX 40 060	1.575in	2.362 - 3.15in	600
TX 16 200	0.63in	7.874 - 13.78in	1000	TX 40 080	1.575in	3.15 - 4.724in	450
TX 16 350	0.63in	13.78 - 24.409in	500	TX 40 120	1.575in	4.724 - 7.874in	270
TX 16 410	0.63in	16.142 - 30.315in	500	TX 40 200	1.575in	7.874 - 13.78in	208
TX 20 050	0.787in	1.969 - 2.756in	950	TX 40 350	1.575in	13.78 - 24.409in	120
TX 20 080	0.787in	3.15 - 4.724in	1500	TX 45 050	1.772in	1.969 - 2.362in	280
TX 20 120	0.787in	4.724 - 7.874in	900	TX 45 060	1.772in	2.362 - 3.15in	500
TX 20 200	0.787in	7.874 - 13.78in	700	TX 45 080	1.772in	3.15 - 4.724in	300
TX 22 050	0.866in	1.969 - 2.362in	1000	TX 45 120	1.772in	4.724 - 7.874in	250
TX 22 080	0.866in	3.15 - 4.724in	1300	TX 45 200	1.772in	7.874 - 13.78in	180
TX 22 120	0.866in	4.724 - 7.874in	650	TX 45 350	1.772in	13.78 - 24.409in	100
TX 22 200	0.866in	7.874 - 13.78in	600	TX 45 500*	1.772in	19.685 - 29.528in	180
TX 22 350	0.866in	13.78 - 24.409in	390	TX 45 700*	1.772in	27.559 - 41.339in	100
TX 22 410	0.866in	16.142 - 30.315in	300	TX 50 050	1.969in	1.969 - 2.362in	400
TX 22 500*	0.866in	19.685 - 29.528in	600	TX 50 060	1.969in	2.362 - 3.15in	350
TX 22 700*	0.866in	27.559 - 41.339in	390	TX 50 080	1.969in	3.15 - 4.724in	300
TX 24 050	0.945in	1.969 - 2.362in	810	TX 50 120	1.969in	4.724 - 7.874in	190
TX 24 080	0.945in	3.15 - 4.724in	1000	TX 50 200	1.969in	7.874 - 13.78in	140
TX 24 120	0.945in	4.724 - 7.874in	600	TX 50 350	1.969in	13.78 - 24.409in	80
TX 24 200	0.945in	7.874 - 13.78in	500	TX 55 050	2.165in	1.969 - 2.362in	400
TX 26 050	1.024in	1.969 - 2.362in	800	TX 55 060	2.165in	2.362 - 3.15in	200
TX 26 080	1.024in	3.15 - 4.724in	900	TX 55 080	2.165in	3.15 - 4.724in	200
TX 26 120	1.024in	4.724 - 7.874in	550	TX 55 120	2.165in	4.724 - 7.874in	160
TX 26 200	1.024in	7.874 - 13.78in	450	TX 55 200	2.165in	7.874 - 13.78in	110
TX 26 350	1.024in	13.78 - 24.409in	260	TX 55 350	2.165in	13.78 - 24.409in	68
TX 26 410	1.024in	16.142 - 30.315in	200	TX 65 050	2.559in	1.969 - 2.362in	220
TX 26 500*	1.024in	19.685 - 29.528in	550	TX 65 060	2.559in	2.362 - 3.15in	220
TX 26 700*	1.024in	27.559 - 41.339in	405	TX 65 080	2.559in	3.15 - 4.724in	170
TX 28 050	1.102in	1.969 - 2.362in	600	TX 65 120	2.559in	4.724 - 7.874in	128
TX 28 080	1.102in	3.15 - 4.724in	900	TX 65 200	2.559in	7.874 - 13.78in	86
TX 28 120	1.102in	4.724 - 7.874in	550	TX 65 350	2.559in	13.78 - 24.409in	46
TX 28 200	1.102in	7.874 - 13.78in	405	TX 85 080	3.346in	3.15 - 3.937in	100
TX 30 050	1.181in	1.969 - 2.362in	1000	TX 85 120	3.346in	4.724 - 7.087in	65
TX 30 080	1.181in	3.15 - 4.724in	750	TX 85 200	3.346in	7.874 - 13.78in	36
TX 30 120	1.181in	4.724 - 7.874in	450	TX 85 350	3.346in	13.78 - 21.654in	20
TX 30 200	1.181in	7.874 - 13.78in	320	TX 85 550	3.346in	21.654 - 39.37in	18
TX 30 350	1.181in	13.78 - 24.409in	200	TX 105 080	4.134in	3.15 - 3.937in	72
TX 30 410	1.181in	16.142 - 30.315in	160	TX 105 120	4.134in	4.724 - 7.087in	48
				TX 105 200	4.134in	7.874 - 13.78in	30

*assembled from three parts (two outer parts and one middle part)



VarioBox

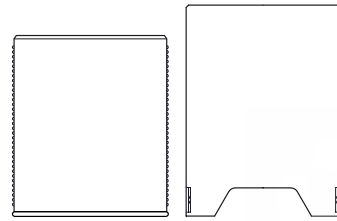

Multi-compartment packaging system for shank tools and longer precision parts (e.g. twist drills, taps, milling cutters etc.)

- packaging with 5 or 10 compartments for twist drills according to DIN 1897, 338, 339, 334 etc.
- variable length adjustment
- speedy efficient packaging
- customized printing possible
- excellent for stacking and storage
- durable and reusable

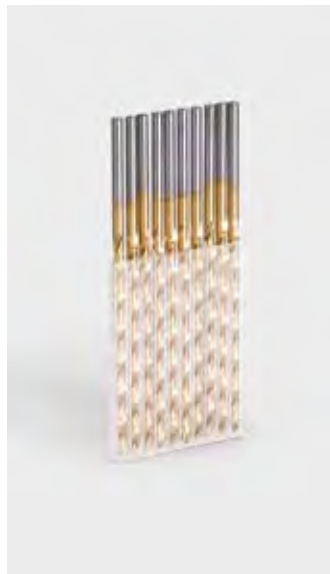

PACKAGING

Outer parts and inner parts are packed separately in individual cartons



MATERIAL

- Polypropylene (PP)
- Recycled plastic



COLORS

- PP transparent or in various attractive standard colors



ACCESSORIES

- With hanger on request

USABLE LENGTHS

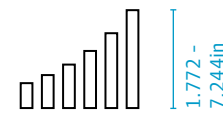

DIAM. UNIT

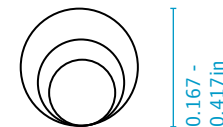

STANDARD COLORS



Product Range

Article	Number of units	Inner diam. of unit	Usable length adjustable	PU
VB 4x 45	10	0.167in	1.772 - 2.756in	1000
VB 4x 72	10	0.167in	2.835 - 4.724in	500
VB 6x 52	10	0.244in	2.047 - 3.307in	350
VB 6x 90	10	0.244in	3.543 - 5.827in	250
VB 10x 80	10	0.417in	3.15 - 5.276in	200
VB 10x105	5	0.417in	4.134 - 7.244in	300

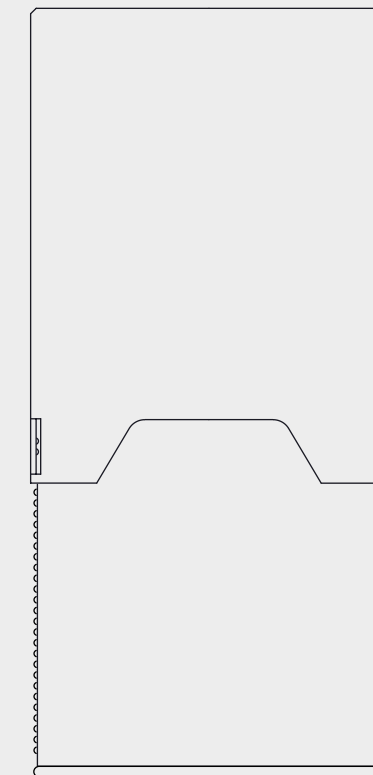

The ideal way to protect shank tools and longer precision parts – safe and simple

VarioPackNT

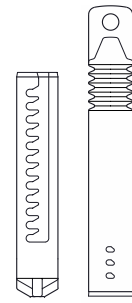

Plastic packaging tubes with dual "bayonet-style" closure for maximum holding force. Ideal packaging for heavy masonry drills

- attractive product presentation due to modern design, and transparency of at least one part of the tube
- dual "bayonet-style" closure holds heavy tools securely in place
- variable length adjustment
- shock absorbing "concertina" tube walls close down firmly on each end of the tool, preventing any movement of the tool within the packaging
- perfect centering of drills
- special interior design of the inner tube section provides additional protection for the drill point
- sturdy integral hanger
- lends itself to automated packaging



PACKAGING

Outer parts and inner parts are packed separately in individual cartons



MATERIAL

- Polyvinylchloride (PVC)



COLORS

- PVC clear or in various attractive standard colors

USABLE LENGTHS

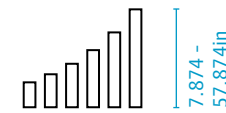

DIAMETER

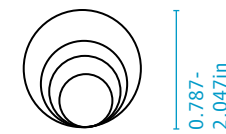

STANDARD COLORS



Product Range

Article	Hanger	Inner diam.	Usable length adjustable	PU
VPNT-A 20 200	round hole hanger	0.787in	7.874 - 9.843in	1000
VPNT-A 20 280	round hole hanger	0.787in	11.024 - 13.78in	500
VPNT-A 20 300	round hole hanger	0.787in	11.811 - 18.504in	500
VPNT-A 20 500	round hole hanger	0.787in	19.685 - 26.378in	250
VPNT-A 26 200	euro hole hanger	1.024in	7.874 - 10.236in	400
VPNT-A 26 300	euro hole hanger	1.024in	11.811 - 13.78in	200
VPNT-A 26 350	euro hole hanger	1.024in	13.78 - 17.717in	200
VPNT-A 26 450	euro hole hanger	1.024in	17.717 - 19.291in	200
VPNT-A 26 460	euro hole hanger	1.024in	18.11 - 23.622in	200
VPNT-A 26 540	euro hole hanger	1.024in	21.26 - 32.283in	200
VPNT-A 26 630	euro hole hanger	1.024in	24.803 - 37.402in	100
VPNT-A 26 1030	euro hole hanger	1.024in	40.551 - 53.15in	100
VPNT-A 32 200	euro hole hanger	1.26in	7.874 - 10.197in	200
VPNT-A 32 280	euro hole hanger	1.26in	11.024 - 13.78in	200
VPNT-A 32 340	euro hole hanger	1.26in	13.386 - 19.685in	200
VPNT-A 32 500	euro hole hanger	1.26in	19.685 - 27.165in	100
VPNT-A 32 580	euro hole hanger	1.26in	22.835 - 37.402in	100
VPNT-A 32 690	euro hole hanger	1.26in	27.165 - 35.433in	100
VPNT-A 32 1100	euro hole hanger	1.26in	43.307 - 57.874in	100
VPNT-A 42 490	euro hole hanger	1.654in	19.291 - 24.409in	50
VPNT-A 42 620	euro hole hanger	1.654in	24.409 - 29.528in	50
VPNT-A 42 650	euro hole hanger	1.654in	25.591 - 37.402in	50
VPNT-A 42 1060	euro hole hanger	1.654in	41.732 - 53.15in	50
VPNT-A 52 280	euro hole hanger	2.047in	11.024 - 13.386in	50
VPNT-A 52 370	euro hole hanger	2.047in	14.567 - 20.079in	50
VPNT-A 52 520	euro hole hanger	2.047in	20.472 - 33.071in	50
VPNT-A 52 540	euro hole hanger	2.047in	21.26 - 27.559in	50
VPNT-A 52 900	euro hole hanger	2.047in	35.433 - 47.244in	25

Euro hole hanger

Round hole hanger

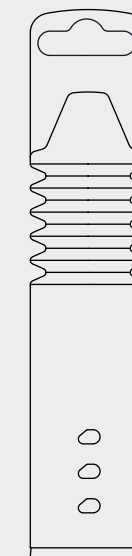

Better safe than sorry – the perfect packaging for heavy masonry drills thanks to a dual “bayonet-style” closure



VarioPack VP and VPN

Telescopic plastic drawing tubes for storage and transportation of drawings, blueprints, posters, documents and much more

VarioBox VP 1

- with telescopic inners ratchet mechanism for variable length adjustment
- all sizes extendable by 400 mm
- screw cap for secure closure and quick access
- additional transparent cover for cap for insertion of label, name and address etc.
- carrying strap length adjustable
- can be printed with logo or advertising slogan
- sturdy, oil, and moisture resistant



1



VarioBox VPN 2

- 2-part version, variable length adjustment, economical
- simple cord system with name plate



2



PACKAGING
Packed assembled



MATERIAL

- 1 **VarioPack VP**
 - Tube, rings and clips: Polyethylene (PE)
 - Cover: Polypropylene (PP)
 - Recycled plastic
 - Bio plastic
- 2 **VarioPack VPN**
 - Polypropylene (PP)
 - Recycled plastic
 - Bio plastic



COLORS

- 1 **VarioPack VP**
 - Tube in black; rings and clips in red
 - Please enquire for other colors or color combinations
- 2 **VarioPack VPN**
 - Tube in red, blue or in various attractive standard colors
 - Cord and name plate in silver



ACCESSORIES

- 2 **VarioPack VPN**
 - Cord, name plate and assembling instruction are enclosed loosely

USABLE LENGTHS



DIAMETER

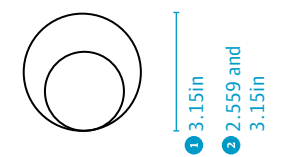

STANDARD COLORS



Product Range

1 VarioPack VP

Article	Inner diam.	Usable length adjustable	PU
VP 80 600/1 K	3.15in	23.622 - 39.37in	25
VP 80 800/6 K	3.15in	31.496 - 47.244in	15
VP 80 1200/10 K	3.15in	47.244 - 62.992in	12
VP 80 1400/12 K	3.15in	55.118 - 70.866in	10
VP 80 1800/13 K	3.15in	70.866 - 86.614in	8



2 VarioPack VPN

Article	Inner diam.	Usable length adjustable	PU
VPN 65 460/1 K	2.559in	18.11 - 26.772in	32
VPN 80 600/16 K	3.15in	23.622 - 39.37in	25

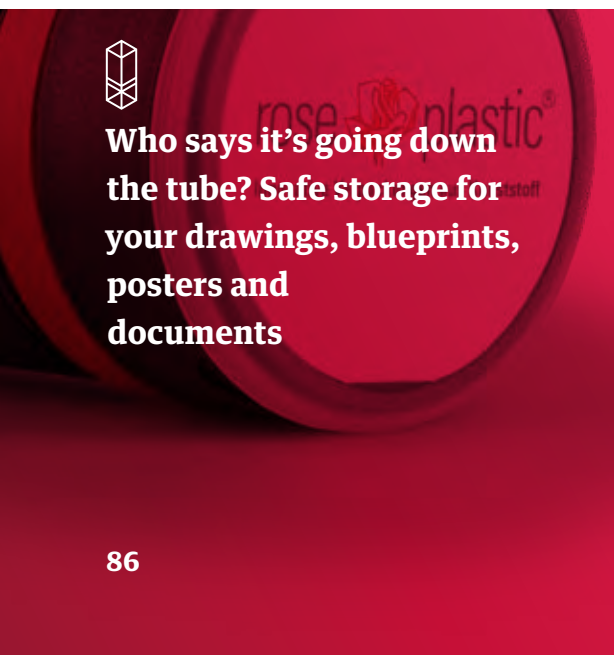
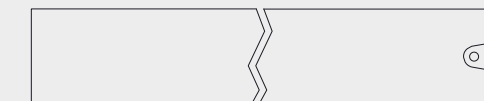

Plastic boxes

Boxes for virtually things in particular.

Our high-quality plastic boxes are in demand as practical and safe packaging for cutting tools as well as other industrial components. They are the first choice of tool retailers and hardware stores – not least thanks to their suitability as high-quality promotional and sales packaging.

anything. And for some

Uni Box

Plastic storage boxes with hinged lid and secure closure
more on page 114



Consumer Box

Plastic boxes with hinged lid and integrated latch
more on page 92



BitPack

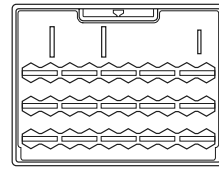

Modular design bit packaging product

BitPack 1

- flexible insert available for 6, 9 or 11 bits plus bit holder
- 3-part with integral "anti-theft" feature



BitPack 30

- holds 30 bits plus a bit holder
- 3-part with integral "anti-theft" feature



PACKAGING

Cover and base are packed separately in individual cartons



MATERIAL

- ABS



COLORS

- Cover in clear; base and insert in various attractive standard colors



ACCESSORIES

- Hanger

HEIGHTS

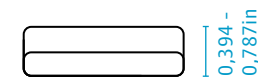

DIMENSION

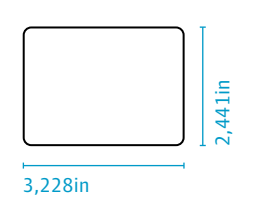

STANDARD COLORS



Product Range

1 BitPack

Article	Version	Dimension	PU
Bit 60 x 80 x 10/1 A	BitPack cover	2,441x3,228x0,394in	500
Bit 60 x 80 x 10/1 I	BitPack base for 60mm bit holder	2,441x3,228x0,394in	500
Bit 60 x 80 x 10/3 I	BitPack base for 55mm bit holder	2,441x3,228x0,394in	500
Bit 60 x 80 x 10/4 I	BitPack base with compartment for bit holder	2,441x3,228x0,394in	500
Bit 60 x 80 x 10/5 I	BitPack base with bit holder up to 60mm	2,441x3,228x0,394in	500
Bit 6/1 E	6 part insert for UT		500
Bit 9/1 E	9 part insert for UT		500
Bit 11/1 E	11 part insert for UT		500

2 BitPack 30

Article	Version	Dimension	PU
Bit 60 x 80 x 10/1 A	BitPack cover	2,441x3,228x0,394in	500
Bit 60 x 80 x 20/1 I	BitPack 30 base	2,441x3,228x0,787in	500
Bit 30/1 E	30 part insert for 60mm bit holder		250
Bit 30/3 E	30 part insert for 55mm bit holder		250

3 Hanger

Article	Version	Dimension	PU
Bit-Hanger 22 x 50/1	euro hole hanger	0,866x1,969in	3000
Bit-Hanger 53 x 83/1	euro hole hanger (can be labelled)	2,087x3,268in	1500

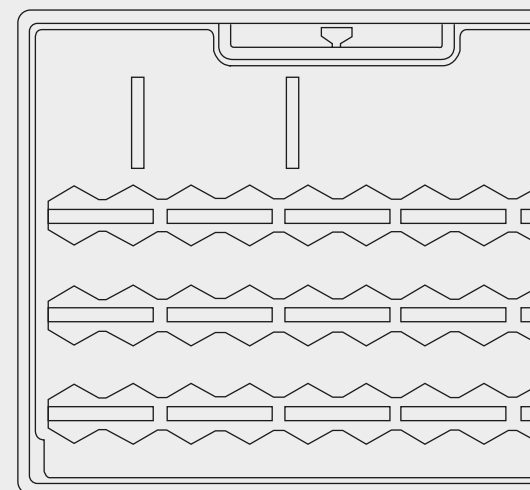

This practical set packaging ensures your "little ones" always stay together

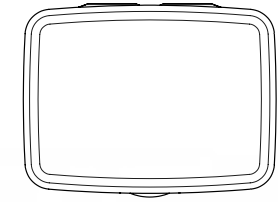

Consumer Box

Plastic boxes with hinged lid and integrated latch

- high quality image
- universal application
- polished lid surface provides high transparency for product visibility
- latch integrated into box contours
- durable hinges
- transparent, solid or translucent colored boxes offer numerous options for diversification
- excellent surface for printing and labeling



Simply brilliant, brilliantly simple: This high-quality plastic box with integrated latch and polished lid surface is the perfect sales packaging



PACKAGING
Carton



MATERIAL
- Polypropylene (PP)
- Recycled plastic



COLORS
- Depending on the material transparent, natural or in various attractive standard colors



ACCESSORIES
- With hanger on request

HEIGHTS

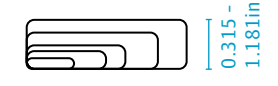

DIMENSION

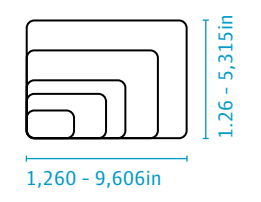

STANDARD COLORS



Product Range

Article	Version	Description	Inner length	Inner width	Inner height	PU
CB 34x34x8/1	1		1.26in	1.26in	0.315in	1000
CB 56x42x10/1	1		2.165in	1.535in	0.394in	400
CB 68x50x13/1	1		2.598in	1.85in	0.512in	470
CB 95x70x17/1	1		3.622in	2.559in	0.669in	340
CB 95x70x17/2	2	w/ insert for hanger	3.622in	2.559in	0.669in	340
CB 95x70x17/3	3	w/ flat lid	3.622in	2.559in	0.669in	340
CB 115x85x26/1	1		4.37in	3.071in	1.024in	172
CB 138x102x30/1	1		5.276in	3.74in	1.181in	88
CB 150x50x30/1	1		5.787in	1.732in	1.142in	180
CB 150x50x30/2	2	w/ insert for hanger	5.787in	1.732in	1.142in	180
CB 180x145x45/1	1		6.811in	5.315in	1.772in	80
CB 246x88x20/1	1		9.606in	3.268in	0.63in	100
CB 246x88x20/2	2	for calipers; w/ hanger insert	9.606in	3.268in	0.63in	100
CB 246x88x20/3	3	w/ holding device for caliper	9.606in	3.268in	0.63in	100
CB 246x88x20/4	4	w/ insert for hanger	9.606in	3.268in	0.63in	100
CB Hanger 44x19/1	1	hanger for ConsumerBox				2000



FivePack



Multi-compartment packaging system with 5 individual detachable units for taps, burrs and shank tools

- versatile packaging combining single unit with multiple packaging
- FivePack: one-piece version with hinged lid
- FivePack Cradle: with "cradles" to support smaller diameter shanks
- user-friendly and efficient detachable units
- no packing and repacking of single items necessary
- each unit is reusable with hinged lid and snap-closure
- speedy handling
- space saving
- excellent for stacking and storage



High five! Five perfectly protected tools in one packaging solution – with individually detachable chambers



PACKAGING

Carton



MATERIAL

- Polypropylene (PP)
- Recycled plastic



COLORS

- Depending on the material transparent, natural or in various attractive standard colors



ACCESSORIES

- Foam inserts (see page 182)

USABLE LENGTHS

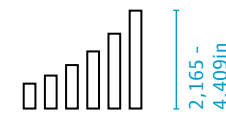

DIAMETER

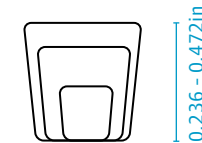

STANDARD COLORS

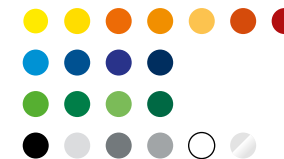

Product Range

FivePack

Article	Number of units	Inner diam. of unit	Inner length	PU
FP 6x55	5	0.236in	2.165in	650
FP 6x72	5	0.236in	2.835in	500
FP 6x85	5	0.236in	3.346in	630
FP 10x68	5	0.394in	2.677in	460
FP 10x84	5	0.394in	3.307in	380
FP 10x105	5	0.394in	4.134in	330
FP 12x91	5	0.472in	3.583in	210
FP 12x112	5	0.472in	4.409in	210

FivePack Cradle

Article	Number of units	Inner diam. of unit	Shank holding diam.	max. head diam.	Inner length	PU
FP-W 6x40/9	5	0.236in	0.128in	0.128in	1.575in	650
FP-W 6x55/9	5	0.236in	0.128in	0.236in	2.165in	650
FP-W 10x68/9	5	0.394in	0.256in	0.394in	2.677in	460
FP-WG 12x91/2	5	0.472in	0.256in	0.472in	3.583in	210



InsertBox InsertClickBox

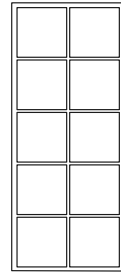

Packaging boxes for carbide inserts

- secure closure through center locking of lid
- simple, quick press-closure of lid
- lid slides open in either direction
- bases and covers are stacked packed, thus suitable for automated loading, closing and labelling
- excellent for stacking and storage



PACKAGING
Base and cover are packed separately in individual cartons



MATERIAL
- Polypropylene (PP)
- Recycled plastic



COLORS
- Cover in transparent, base in various attractive standard colors

DIVIDERS

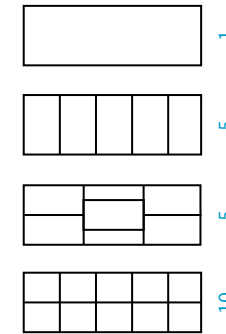

STANDARD COLORS

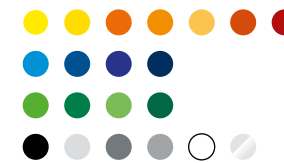

Our “division manager” offers maximum protection for sensitive carbide inserts

Product Range

InsertBox

Article	Size designation	Number of units	Inner length of unit	Inner width of unit	Inner height	PU
IB-W 10.5x5.2	1	10	0.413in	0.413in	0.205in	700
IB-W 17.8x6.5	2A	10	0.701in	0.701in	0.256in	1200
IB-W 17.8x8.5	2B	10	0.701in	0.701in	0.335in	1200
IB-W 95.2x37.2x8.5	2C	1	3.748in	1.465in	0.335in	1200
IB-W 25.7x8.2	3A	10	1.012in	1.016in	0.323in	450
IB-W 25.7x12.8	3B	10	1.012in	1.016in	0.504in	450
IB-W 25.7x9	3C	5	2.047in	1.012in	0.354in	450
IB-W 25.5x20.5	3D	10	1.004in	1.004in	0.807in	450
IB-W 30.0x10.5	4A	5	1.181in	1.181in	0.413in	450
IB-W 30.0x17.5x10.5	4B	10	1.181in	0.689in	0.413in	450
IB-W 35.0x10.5	5A	5	1.378in	1.378in	0.413in	380
IB-W 35.0x13.5	5B	5	1.378in	1.378in	0.531in	380
IB-W 20.5x39.5x15	6	5	1.555in	0.807in	0.591in	450

InsertClickBox

Article	Size designation	Number of units	Inner length of unit	Inner width of unit	Inner height	PU
ICB-W 17.8x6.5	2A	10	0.700in	0.700in	0.255mm	5000
ICB-W 95x37x6.5	2D	1	3.740in	1.456in	0.255mm	5000
ICB-W 25.7x8.2	3A	10	1.011in	1.015in	0.322mm	300



InsertBoxConnect

Individual packaging that can be connected to form sets. Ideal for the safe transport of high-quality indexable inserts (PCD/CBN).

- plastic box with or without center post for holding ISO indexable cutting inserts
- the center post as well as distance rings in the base and lid prevent contact of the cutting edges with the packaging
- two sizes and different holding geometries provide the optimal packaging for a wide variety of insert geometries
- in the closed box, the pin is stabilized by an additional fixation in the lid and thus remains intact even in case of heavy impacts
- the boxes can be connected to each other to form sets using a plug-in function on all sides
- interconnected boxes form a plain, continuous surface for labels and inscriptions
- secure integrated latch and hinged lid
- suitable for automated processes
- no packing and repacking of single units necessary
- sturdy, oil and moisture resistant
- sustainable, resealable, reusable and recyclable
- excellent for stacking and storage



PACKAGING
Carton



MATERIAL
- Polypropylene (PP)
- Recycled plastic



COLORS
- Depending on the material transparent, natural or in various attractive standard colors

STANDARD COLORS



Product Range

Article	Description	Inner length	Inner width	Inner height	Diameter tool holder	Max. tool height	PU
IBC 28x25x8/1	without centering	1.102in	0.984in	0.335in	-	0.331in	440
IBC 28x25x8/2	with centering	1.102in	0.984in	0.335in	0.102in	0.102in	440
IBC 28x25x8/3	with centering	1.102in	0.984in	0.335in	0.15in	0.193in	440
IBC 45x42x12/1	without centering	1.772in	1.654in	0.492in	-	0.488in	540
IBC 45x42x12/2	with centering	1.772in	1.654in	0.492in	0.146in	0.252in	540



Special protection for sensitive tools: the InsertBox Connect ensures undamaged inserts

Insert Box HighS

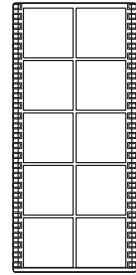

High-quality plastic packaging boxes for carbide inserts

- many packing possibilities due to the number of compartments and post to center tools
- functional and user-friendly high quality design
- clear ABS material allows product presentation
- sliding lid with ratchet mechanism and stop device
- cost-conscious solution due to long-term re-usability
- easy handling, suitable for automated loading
- excellent for stacking, additional fit through easy clamping in the cover and bottom
- customized branding or embossing of brand/logo possible
- foam pad insert to be put into cover of pack for additional protection available



PACKAGING
Base and cover are packed separately in individual cartons



MATERIAL
- Base in PS / ABS
- Cover in ABS



COLORS
- Cover in clear;
base in various attractive standard colors



ACCESSORIES
- Foam pad inserts

DIVIDERS

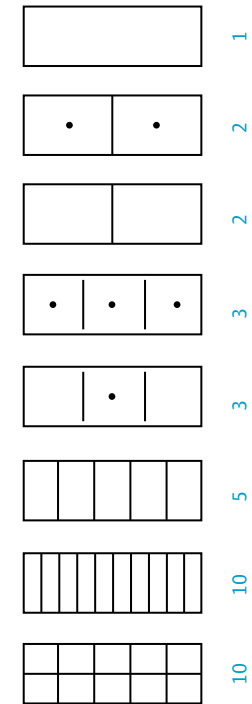

STANDARD COLORS



Product Range

InsertBox HighS

Article	Number of units	Compartment design	Inner length unit	Inner width unit	Inner height	PU
IH 31x61x10/1	1	without compartments	1.22in	2.421in	0.382in	1200
IH 31x61x10/2	3	1 cylindrical center spigot	1.22in	0.776in	0.382in	1200
IH 31x61x10/3	3	3 conical center spigots	1.22in	0.776in	0.382in	1200
IH 31x61x10/4	3	3 cylindrical center spigots	1.22in	0.776in	0.382in	1200
IH 31x61x10/5	10	longish compartments	1.22in	0.205in	0.421in	1200
IH 31x61x10/6	2	square compartments	1.22in	1.185in	0.382in	1200
IH 31x61x10/7	2	2 cylindrical center spigots	1.22in	1.185in	0.382in	1200
IH 37x94x6.5/1	1	without compartments	1.441in	3.701in	0.256in	780
IH 37x94x6.5/2	10	square compartments	0.697in	0.697in	0.256in	780
IH 37x94x6.5/3	10	longish compartments	1.441in	0.327in	0.256in	780
IH 37x94x10/1	1	without compartments	1.441in	3.685in	0.382in	
IH 37x94x10/2	2	2 cylindrical center spigots	1.441in	1.819in	0.382in	
IH 37x94x10/3	10	square compartments	0.697in	0.697in	0.382in	
IH 52x133x8.5/1	1	without compartments	2.047in	5.236in	0.331in	585
IH 52x133x8.5/2	10	square compartments	1.012in	1.012in	0.331in	585
IH 52x133x8.5/3	10	longish compartments	2.047in	0.48in	0.331in	585
IH 52x133x13/1	1	without compartments	2.047in	5.236in	0.535in	400
IH 52x133x13/2	10	square compartments	1.012in	1.012in	0.535in	400
IH 52x133x13/3	5	longish compartments	2.047in	1.004in	0.535in	400
IH 52x133x20/1	1	without compartments	2.047in	5.236in	0.787in	265
IH 52x133x20/2	10	square compartments	0.984in	0.984in	0.787in	265
IH 52x133x20/3	10	longish compartments	2.047in	0.465in	0.787in	265

Foam pad inserts for InsertBox HighS

Article	Suitable for	Number of compartments	Compartment size	Outer height	PU
SE IH 31x61x10 K 1 A.	IH 31x61x10	1	38x23	0.394in	5000
SE IH 31x61x10 K 2 A.	IH 31x61x10	2	20x23	0.394in	5000
SE IH 37x93.5x5.5/1 K 5 A.	IH 37x94x6.5	5	15x30	0.217in	3000
SE IH 37x93.5x5.5/2 K 10 A.	IH 37x94x6.5	10	14x15	0.256in	3000
SE IH 37x93.5x6.5/1 K 5 A.	IH 37x94x6.5	5	15x30	0.217in	3000
SE IH 37x93.5x6.5/2 K 10 A.	IH 37x94x6.5	10	14x15	0.256in	3000
SE IH 52x133x8.5/1 K 10 A.	IH 52x133x8.5	10	19x20	0.236in	3000
SE IH 52x133x13/2 A.	IH 52x133x13/2	2	46,4x46,4	0.394in	3000
SE IH 52x133x13/6 A.	IH 52x133x13/6	6	30x20	0.394in	3000
SE IH 52x133x13 B	IH 52x133x13/6	0	-	0.118in	3000



Seriously secure protection for sensitive cutting edges. One box, many variants, multiple benefits



Insert Split Box

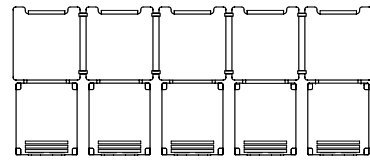

Multi-compartment packaging system for carbide inserts – one-piece version with 5 individual detachable hinged boxes

- versatile packaging combining single unit with multiple packaging
- no packing and repacking of single units necessary
- each unit is reusable with hinged lid and snap-closure
- excellent for stacking and storage

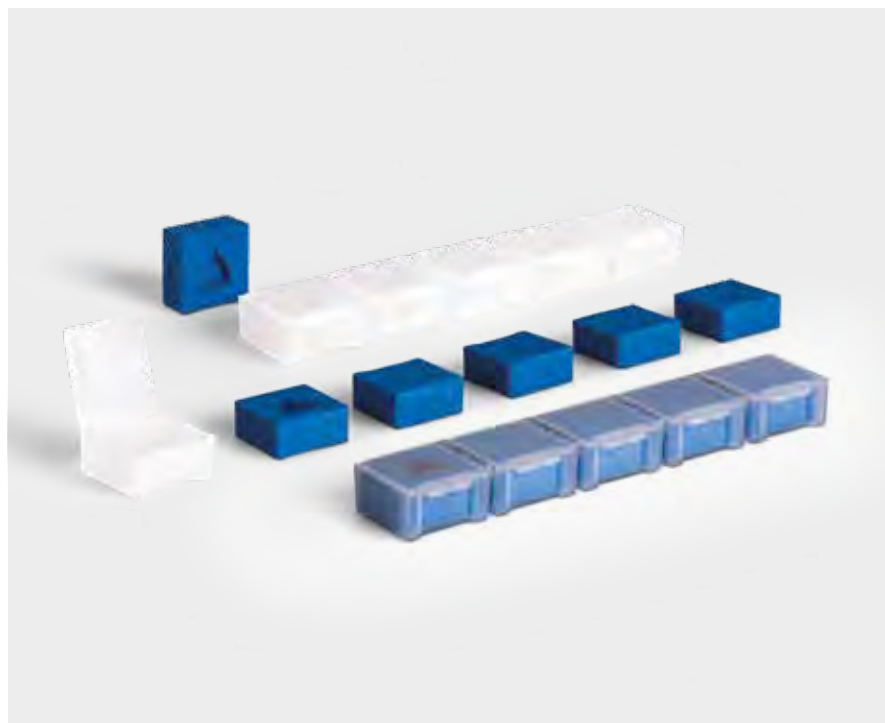
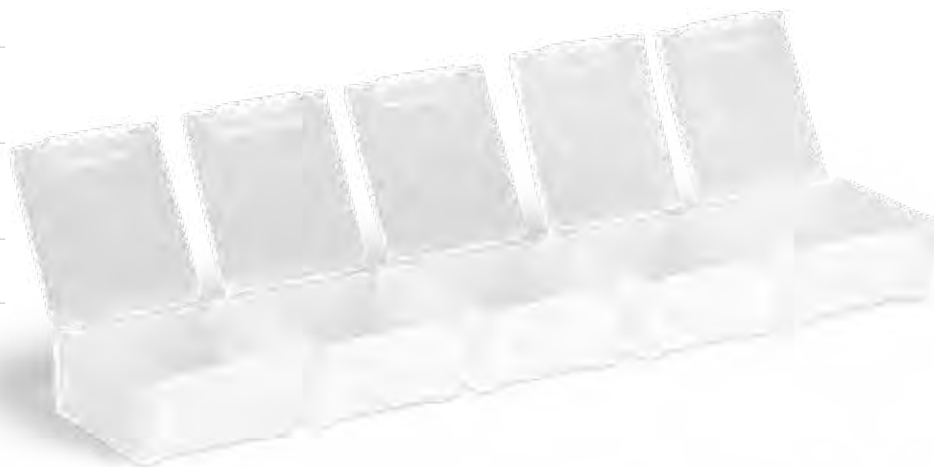

Think outside the box: This secure, multi-compartment packaging with individually detachable hinged boxes provides excellent protection for cutting inserts



PACKAGING

Carton



MATERIAL

- Polypropylene (PP)
- Recycled plastic



COLORS

- Depending on the material transparent, natural or in various attractive standard colors



ACCESSORIES

- Foam inserts (see page 180)

HEIGHTS



DIMENSIONS

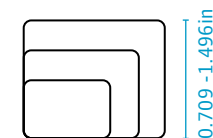

STANDARD COLORS



Product Range

Article	Number of units	Inner length unit	Inner width unit	Inner height	PU
ISB 18x18x8.5	5	0.709in	0.709in	0.335in	650
ISB 28x28x12.7	5	1.102in	1.102in	0.5in	200
ISB 38x38x16	5	1.496in	1.496in	0.63in	200

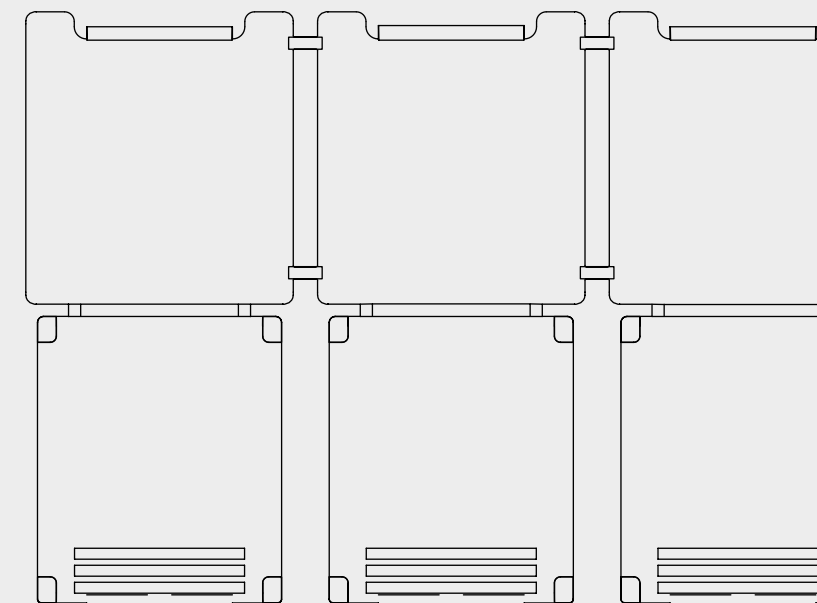

Insert Split Box SL

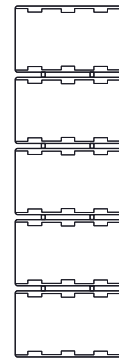

Multi-compartment packaging system for carbide inserts – two-piece version with 5 individual detachable boxes

- versatile packaging combining single unit with multiple packaging
- no packing and repacking of single units necessary
- separate highly transparent lids snap into each middle and end position and provides therefore additional protection during opening/closing
- cover slides open in either direction
- suitable for small lot sizes and equipping tool dispensers
- stackable due to the special guiding ridges
- suitable for automated loading, closing and labeling
- smooth top and bottom surface for labeling



Super practical – 5 detachable individual boxes offer maximum safety for carbide inserts



PACKAGING
Base and cover are packed separately in individual cartons



MATERIAL
– Base and cover in impact resistant ABS plastics



COLORS
– Cover in clear; base in gray or in various attractive standard colors

DIVIDERS

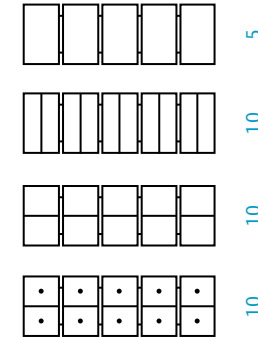

STANDARD COLORS



Product Range

Article	Number of units	Compartment design	Inner length unit	Inner width unit	Inner height	PU
ISBSL 18x37x8.5/1	5	without compartments	1.457in	0.709in	0.335in	500
ISBSL 18x37x8.5/2	10	lengthwise dividers	1.457in	0.335in	0.335in	500
ISBSL 18x37x8.5/3	10	widthwise dividers	0.709in	0.709in	0.335in	500
ISBSL 18x37x8.5/4	10	widthwise divider+center pin	0.709in	0.709in	0.335in	500
ISBSL 30x62x13/1	5	without compartments	2.441in	1.201in	0.512in	190
ISBSL 30x62x13/2	10	widthwise dividers	1.201in	1.201in	0.512in	190

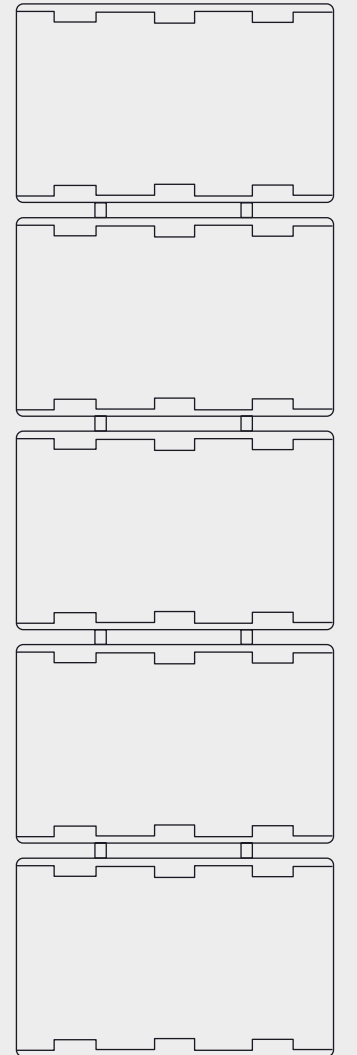

Micro Box MB10

Packaging boxes with 10 holding devices for sensitive micro drills, precision drills, precision milling cutters and PCB drills

- simple and convenient handling thanks to ergonomic shaped closing system
- integrated clamping device holds tools safely in place
- both sides of pack close simultaneously, to trigger an integral clamping mechanism, which holds tools securely in place
- optional one-sided or two-sided length stop in the outer part



Small, smaller, micro (tools) – the integrated clamping device holds your smallest tools safely in place



PACKAGING

Carton



MATERIAL

- Box: K-Resin
- Insert 2.35mm: TPE
- Insert 3.175mm: PS



COLORS

- Box in clear, insert in various attractive standard colors

SHANK DIAM.



STANDARD COLORS

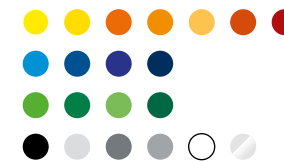

Product Range

Article	Version	Description	Number of holding devices	Shank diam.	Shank diam. (in.)	PU
MB 10/1 2.35 K	1	clamping device on one side	10	0.093in		1000
MB 10/2 2.35 K	2	clamping device on both sides	10	0.093in		1000
MB 10/1 3.175 K	1	clamping device on one side	10	0.125in	1/8	1000
MB 10/2 3.175 K	2	clamping device on both sides	10	0.125in	1/8	1000

Micro Box MB50

Packaging boxes with 50 holding devices for sensitive micro drills, precision drills, precision milling cutters and PCB drills

- two separate parts allowing a variety of color combinations
- with integrated insert for 50 tools, optional with clamping device or clamping device with springs for additional protection of sensitive tool tips
- empty box combined with foam insert offers universal application
- excellent for stacking and storage



Product Range

MicroBox MB50

Article	Version	Description	Shank diam.	Shank diam. (in.)	PU
MB 50/1 S	1	without compartments			200
MB 50/2 S	2	w/ 50 holding devices	0.125in	1/8"	200

MicroBox MB50 Clamping Device

Article	Description	PU
MB 50 clamping device	clamping device w/o spring	535
MB 50 clamping device w.spring	clamping device w/ spring	692



PACKAGING

Parts are packed separately in individual cartons



MATERIAL

- Cover, base and clamping device: Polystyrene (PS)
- Clamping device with spring: Polypropylene (PP)



COLORS

- Cover in clear; base and clamping device in various attractive standard colors

STANDARD COLORS



Micro Vario Box

Packaging box with 10 holding devices for precision tools, micro drills, taps, milling cutters, diamond tools according to DIN 1897/338/339/334 etc.

- two parts, cover and base allowing for a variety of two-color combinations
- extremely strong
- excellent for stacking and storage
- durable and reusable

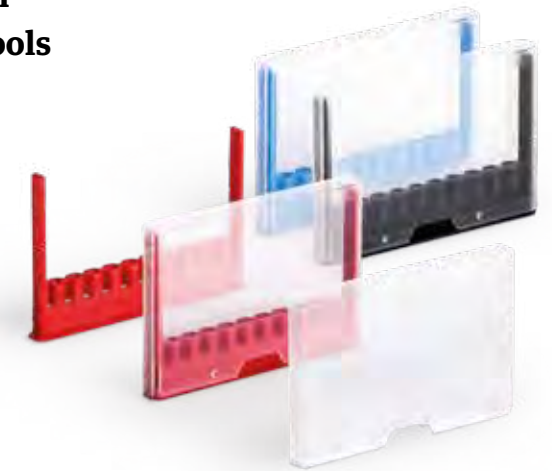

Product Range

Article	Number of holding devices	Shank diam.	Usable length fixed	PU
MVB 1.5	10	0.039in	1,614in	1000
MVB 1.0	10	0.059in	1,614in	1000
MVB 2.0	10	0.079in	1,614in	1000
MVB 3.0	10	0.118in	1,614in	1000
MVB 3.175	10	0.125in	1,614in	1000



PACKAGING

Base and cover are packed separately in individual cartons



MATERIAL

- Polypropylene (PP)



COLORS

- Cover in transparent, base in various attractive standard colors

STANDARD COLORS



DIY-Box

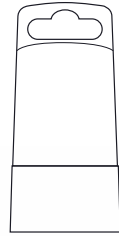

Plastic boxes with integrated hanger.
Ideal as packaging for profile cutters

DIY-Box

- DYP 24x24/1 I and DYP 40x40/1 I: base with "stepped" hole to accept 6 mm and 8 mm shank diameters
- maximum tool size 40 mm diameter x 70 mm height

DIY-FlapBox

- with flap mechanism and anti-theft closure
- maximum tool size 40 mm diameter x 70 mm height
- box with euro hanger



1



2



PACKAGING

- 1 Base plug and outer part are packed separately in individual cartons
- 2 Packed assembled



MATERIAL

- 1 **DIY-Box**
 - Base plug: Polypropylene (PP)
 - Outer part: Polyvinylchloride (PVC) / Polypropylene (PP)
- 2 **DIY-FlapBox**
 - box: polystyrene (PS)
 - cover: ABS plastic
 - hanger: polypropylene (PP)
 - safety pin: polyethylene (PE)



COLORS

- 1 **DIY-Box**
 - Base in various attractive standard colors
 - Outer part in clear (PVC) or transparent (PP)
- 2 **DIY-FlapBox**
 - Cover in clear, box, hanger and safety pin in various attractive standard colors on request

DIMENSIONS

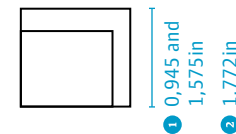

SHANK DIAM.

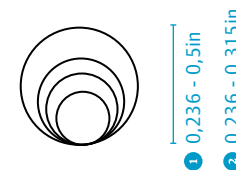

STANDARD COLORS



Product Range

1 DIY-Box base plug

Article	Part type	Inner length	Inner width	Shank diam.	Shank diam. (in.)	PU
DYP 24x24/1 I	base plug	0.945in	0.945in	0,236in		700
DYP 40x40/1 I	base plug	1.575in	1.575in	0,236in		480
DYP 40x40/2 I	base plug	1.575in	1.575in	0.5in	1/2"	480
DYP 40x40/3 I	base plug	1.575in	1.575in	0.394in		480

DIY-Box outer part

Article	Part type	Hanger	Inner length	Inner width	Inner height	PU
DYP-A 24x24 045/1 A	outer part	round hole hanger	0.945in	0.945in	1.772in	700
DYP-A 24x24 057/1 A	outer part	round hole hanger	0.945in	0.945in	2.244in	500
DYP-A 40x40 050/1 A	outer part	euro hole hanger	1.575in	1.575in	1.969in	240
DYP-A 40x40 050/2 A	outer part	euro hole hanger	1.575in	1.575in	1.969in	200
DYP 40x40 050/2 A	outer part	-	1.575in	1.575in	1.969in	3500

2 DIY-FlapBox

Article	Inner length	Inner width	Inner height	Shank diam.	Shank diam. (in.)	PU
DYP 43x43/9	1.693in	1.772in	2.953in	0.236in	1/4	230
DYP 43x43/10	1.693in	1.772in	2.953in	0.315in	5/16	230

The ideal packaging for profile cutters – maximum protection with effective product presentation



SplitPack

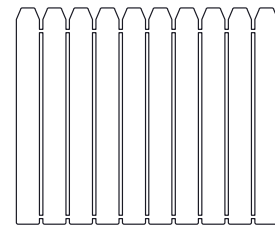

Multi-compartment packaging system with 10 individual detachable units for tap drills, burrs and shank tools

- versatile packaging combining single unit with multiple packaging
- SplitPack: 2-part version with separate base and lid (SP 4x40 and SP 4x60 are one-piece version)
- SplitPack with shankholding: with integrated shankholding feature in lid
- detachable units make this product very efficient and user-friendly
- no packing and repacking of single items necessary
- each unit is reusable with hinged lid and snap-closure
- speedy handling
- space saving
- excellent for stacking and storage



The only packaging we sell that's allowed to be broken. For safe transport and protection of multiple shank tools



PACKAGING

Outer parts and inner parts are packed separately in individual cartons



MATERIAL

- Polypropylene (PP)
- Recycled plastic



COLORS

- Depending on the material transparent, natural or in various attractive standard colors



ACCESSORIES

- Foam inserts (see page 182)

USABLE LENGTHS

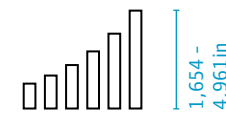

DIAMETER

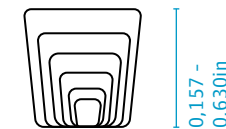

STANDARD COLORS



Product Range

SplitPack

Article	Number of units	Inner diam. unit	Inner length	PU
SP 4x40/2	10	0.157in	1.654in	700
SP 6x40/2	10	0.236in	1.654in	520
SP 6x50/2	10	0.236in	1.969in	780
SP 6x66/2	10	0.236in	2.598in	625
SP 6x80/2	10	0.236in	3.15in	500
SP 6x100/2	10	0.236in	4.055in	405
SP 8x66/2	10	0.315in	2.638in	600
SP 8x80/2	10	0.315in	3.228in	500
SP 8x100/2	10	0.315in	4.094in	420
SP 8x125/2	10	0.315in	4.961in	340
SP 10x66/2	10	0.394in	2.638in	420
SP 10x80/2	10	0.394in	3.228in	360
SP 10x100/2	10	0.394in	4.094in	300
SP 10x125/2	10	0.394in	4.961in	250
SP 12x80/2	5	0.472in	3.346in	525
SP 12x95/2	5	0.472in	3.74in	360
SP 12x110/2	5	0.472in	4.488in	400
SP 16x80/2	5	0.63in	3.307in	330
SP 16x110/2	5	0.63in	4.488in	250

SplitPack with shankholding

Article	Number of units	Inner diam. unit	Shankholding diam	Inner length	PU
SP 6x50-2/2	10	0.236in	0.079in	1.969in	780
SP 6x50-2.35/2	10	0.236in	0.093in	1.969in	780
SP 6x50-2.8/2	10	0.236in	0.11in	1.969in	780
SP 6x50-3/2	10	0.236in	0.118in	1.969in	780
SP 6x66-2.35/2	10	0.236in	0.093in	2.598in	625
SP 6x66-3/2	10	0.236in	0.118in	2.598in	625
SP 8x66-3/2	10	0.315in	0.118in	2.638in	600
SP 10x80-4/2	10	0.394in	0.157in	3.228in	360
SP 10x80-6/2	10	0.394in	0.236in	3.228in	360
SP 16x80-6/2	5	0.63in	0.236in	3.307in	330



UniBox

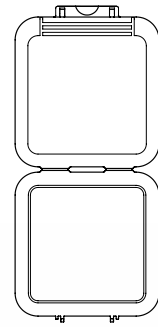

Plastic storage boxes with hinged lid and secure closure

- secure press closure and hinged lid
- speedy handling
- excellent for stacking and storage
- customized printing possible
- durable and reusable
- sturdy, oil, and moisture resistant



Multi-talent, all-rounder, uni-versal genius. This box can be used for almost everything



PACKAGING

Carton



MATERIAL

- Polypropylene (PP)
- Recycled plastic



COLORS

- Depending on the material transparent, natural or in various attractive standard colors



ACCESSORIES

- With hanger on request
- Foam inserts (see page 180)

HEIGHTS

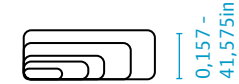

DIMENSIONS

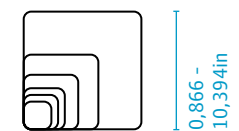

STANDARD COLORS



Product Range

UniBox square

Article	Version (Compartment design)	Inner length	Inner width	Inner height	PU
UB 22x8	1 und 2	0.866in	0.866in	0.315in	1500
UB 35x4	1 und 3 (centering-Ø 1.8mm/0.07")	1.457in	1.457in	0.157in	1000
UB 35x8	1 und 2	1.417in	1.417in	0.315in	1000
UB 35x12	1 und 2	1.378in	1.378in	0.472in	1000
UB 35x18	1	1.378in	1.378in	0.709in	750
UB 35x25	1	1.378in	1.378in	0.984in	600
UB 35x40	1	1.378in	1.378in	1.575in	400
UB 47x6	1, 2, 3 (centering-Ø 4.85mm/0.19") und 8 (centering-Ø 5mm/0.2")	1.929in	1.929in	0.236in	750
UB 47x19	1 und 2	1.85in	1.85in	0.748in	730
UB 47x40	1	1.693in	1.693in	1.575in	320
UB 58x6	1 und 3 (centering-Ø 10mm/0.39")	2.48in	2.48in	0.236in	450
UB 58x12	1 und 3 (centering-Ø 10mm/0.39")	2.441in	2.441in	0.472in	300
UB 58x25	1	2.362in	2.362in	0.984in	400
UB 58x40	1	2.283in	2.283in	1.575in	330
UB 67x6	1 und 3 (centering-Ø 10mm/0.39")	2.756in	2.756in	0.236in	350
UB 67x12	1 und 3 (centering-Ø 10mm/0.39")	2.717in	2.717in	0.472in	250
UB 67x26	1, 2 und 3 (centering-Ø 10mm/0.39")	2.638in	2.638in	1.024in	300
UB 67x40	1	2.638in	2.638in	1.575in	225
UB 85x6	1 und 3 (centering-Ø 16mm/0.63")	3.622in	3.622in	0.236in	400
UB 85x12	1 und 3 (centering-Ø 16mm/0.63")	3.583in	3.583in	0.472in	250
UB 85x25	1 und 3 (centering-Ø 16mm/0.63")	3.465in	3.465in	0.984in	150
UB 85x40	1 und 3 (centering-Ø 16mm/0.63")	3.386in	3.386in	1.575in	150
UB 100x6	1 und 3 (centering-Ø 16mm/0.63")	4.134in	4.134in	0.236in	300
UB 100x12	1, 3 (centering-Ø 16mm/0.63") und 4 (centering-Ø 9.9mm/0.39")	4.055in	4.055in	0.472in	200
UB 100x25	1 und 3 (centering-Ø 16mm/0.63")	3.976in	3.976in	0.984in	250
UB 100x40	1, 3 (centering-Ø 16mm/0.63") and 4 (centering-Ø 20mm/0.79")	3.937in	3.937in	1.575in	110
UB 125x6	1 und 3 (centering-Ø 16mm/0.63")	5.236in	5.236in	0.236in	180
UB 125x12	1 und 3 (centering-Ø 16mm/0.63")	5.197in	5.197in	0.472in	120
UB 125x25	1 and 3 (centering-Ø 16mm/0.63") and 4 (centering-Ø 22mm/0.87")	5.118in	5.118in	0.984in	150
UB 125x40	1 und 3 (centering-Ø 16mm/0.63")	5in	5in	1.575in	130
UB 160x6	1 und 3 (centering-Ø 16mm/0.63")	6.496in	6.496in	0.236in	120
UB 160x12	1 und 3 (centering-Ø 16mm/0.63")	6.457in	6.457in	0.472in	90
UB 160x25	1 und 3 (centering-Ø 16mm/0.63")	6.417in	6.417in	0.984in	100
UB 160x40	1 und 3 (centering-Ø 16mm/0.63")	6.299in	6.299in	1.575in	70
UB 200x6	1 und 3 (centering-Ø 16mm/0.63")	8.189in	8.189in	0.236in	80
UB 200x12	1 und 3 (centering-Ø 16mm/0.63")	8.15in	8.15in	0.472in	50
UB 200x25	1 und 3 (centering-Ø 16mm/0.63")	8.071in	8.071in	0.984in	60
UB 200x40	1 und 3 (centering-Ø 16mm/0.63")	7.874in	7.874in	1.575in	40
UB 250x6	1 und 3 (centering-Ø 16mm/0.63")	10.394in	10.394in	0.236in	40
UB 250x12	1 und 3 (centering-Ø 16mm/0.63")	10.354in	10.354in	0.472in	28
UB 250x25	1 und 3 (centering-Ø 16mm/0.63")	10.236in	10.236in	0.984in	35

Version 1 = without centering; Version 2 = with conical centering;

Version 3, 4 and 8 = with cylindrical centering

Product Range

UniBox rectangular

Article	Compartment design	Description	Length	Width	Height	PU
UB 52x36x5/1	without compartments		2.047in	1.417in	0.197in	1200
UB 18x55x7/1	without compartments		2.165in	0.709in	0.276in	1000
UB 18x55x7/2	for set of 3 hand taps	M5, compartment size 6.5x55	2.165in	0.709in	0.276in	1000
UB 18x55x7/3	with 10 compartments		2.165in	0.709in	0.276in	1000
UB 18x55x25/1	without compartments		2.165in	0.709in	0.984in	500
UB 18x69x7/1	without compartments		2.717in	0.709in	0.276in	1000
UB 18x69x7/2	for set of 3 hand taps	M6, compartment size 6.5x69	2.717in	0.709in	0.276in	1000
UB 18x69x25/1	without compartments		2.717in	0.709in	0.984in	500
UB 69x45x26/1	without compartments		2.717in	1.772in	1.024in	350
UB 69x45x41/1	without compartments		2.717in	1.772in	1.614in	225
UB 31x82x11/1	without compartments		3.228in	1.22in	0.433in	650
UB 31x82x11/2	for set of 3 hand taps	M10, compartment size 11x82	3.228in	1.22in	0.433in	650
UB 31x82x40/1	without compartments		3.228in	1.22in	1.575in	330
UB 53x107x18/1	without compartments		4.213in	2.087in	0.709in	250
UB 53x107x18/2	for set of 3 hand taps	M16, compartment size 17x107	4.213in	2.087in	0.709in	250
UB 53x107x40/1	without compartments		4.213in	2.087in	1.575in	180
UB 59x126x22/1	without compartments		4.961in	2.323in	0.866in	140
UB 59x126x22/2	for set of 3 hand taps	M20, compartment size 20x126	4.961in	2.323in	0.866in	140
UB 59x126x40/1	without compartments		4.961in	2.323in	1.575in	120
UB 82x138x27/1	without compartments		5.433in	3.228in	1.063in	90
UB 82x138x27/2	for set of 3 hand taps	M24, compartment size 26x138	5.433in	3.228in	1.063in	90
UB 82x138x40/1	without compartments		5.433in	3.228in	1.575in	60

Inserts and rings for UniBox square

Article	Suitable for	Outer diam.	Outer diam. (in.)	Inner diam.	PU
Spring insert	UniBox 35x4/3				6000
UB-Ring 8/5	UniBox 47	0.315in		0.197in	6000
UB-Ring 10/5	UniBox 47	0.394in		0.197in	6000
UB-Ring 13/10	UniBox 67	0.512in		0.394in	6000
UB-Ring 16/10	UniBox 67	0.63in		0.394in	6000
UB-Ring 20/10	UniBox 67	0.787in		0.394in	6000
UB-Ring 22/10	UniBox 67	0.866in		0.394in	6000
UB-Ring 22/16	UniBox 85/100/125/160/200/250	0.866in		0.63in	6000
UB-Ring 25,4/16 (1)	UniBox 85/100/125/160/200/250	1in	1	0.63in	6000
UB-Ring 27/16	UniBox 85/100/125/160/200/250	1.063in		0.63in	6000
UB-Ring 31.75/16 (1.25)	UniBox 85/100/125/160/200/250	1.25in	1 1/4	0.63in	6000
UB-Ring 32/16	UniBox 85/100/125/160/200/250	1.26in		0.63in	3000
UB-Ring 38.1/16 (1.5)	UniBox 85/100/125/160/200/250	1.5in	1 1/2	0.63in	4000
UB-Ring 40/16	UniBox 85/100/125/160/200/250	1.575in		0.63in	3000
UB-Ring 50/16 (2)	UniBox 85/100/125/160/200/250	1.969in	2	0.63in	1500

PACKAGING
Carton

MATERIAL
- Polypropylene (PP)
- Recycled plastic

COLORS
- Depending on the material
transparent, natural or in various attractive standard colors

ACCESSORIES
- With hanger on request

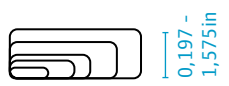
HEIGHTS

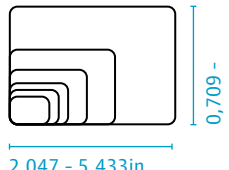
DIMENSIONS

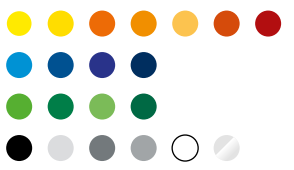
STANDARD COLORS



UniBox...

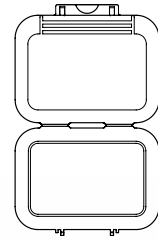

Plastic storage boxes with hinged lid and secure closure

...for Micro Tools ①

- shankholding through integral clips
- secure press closure and hinged lid
- excellent for stacking and storage

...for Spade Drill Inserts ②

- optimum fit through center post
- secure press closure and hinged lid
- durable and reusable
- excellent for stacking and storage
- sturdy, oil, and moisture resistant



PACKAGING

Carton



MATERIAL

- Polypropylene (PP)



COLORS

- PP transparent or in various attractive standard colors

HEIGHTS



DIMENSIONS

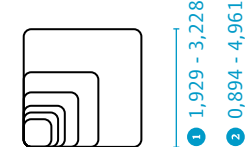

① 1,220 - 1,929in

② 0,709 - 2,323in

SHANK DIAM.

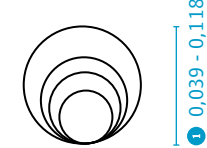

STANDARD COLORS



Product Range

① UniBox for Micro Tools

Article	Inner length	Inner width	Inner height	Number of holding devices	Shank diam.	PU
UB 47x6/4	1.929in	1.929in	0.236in	10	0.039in	750
UB 47x6/5	1.929in	1.929in	0.236in	10	0.059in	750
UB 47x6/6	1.929in	1.929in	0.236in	10	0.079in	750
UB 47x6/9	1.929in	1.929in	0.236in	10	0.118in	750
UB 47x6/10	1.929in	1.929in	0.236in	10	0.075in	750
UB 47x8/7	1.929in	1.929in	0.315in	6	0.093in	600
UB 52x36x5/2	2.047in	1.417in	0.197in	10	0.091in	1200
UB 31x82x7/2	3.228in	1.22in	0.276in	10	0.11in	850

② UniBox for Spade Drill Inserts

Article	Suitable for	Number of holding devices	Inner length	Inner width	Inner height	PU
UB 22x8/4	series Y/Z	2	0.894in	0.894in	0.315in	1000
UB 35x8/5	series 0	2	1.398in	1.398in	0.315in	1000
UB 35x8/4	series 1	1	1.398in	1.398in	0.315in	1000
UB 35x8/3	series 2	1	1.398in	1.398in	0.315in	1000
UB 18x55x7/4	series 3	1	2.165in	0.709in	0.276in	1000
UB 31x82x11/4	series 4	1	3.228in	1.22in	0.433in	650
UB 31x82x11/3	series 5	1	3.228in	1.22in	0.433in	650
UB 53x107x18/3	series 6/7	1	4.213in	2.087in	0.709in	250
UB 59x126x22/3	series 8	1	4.961in	2.323in	0.866in	140

Standardization

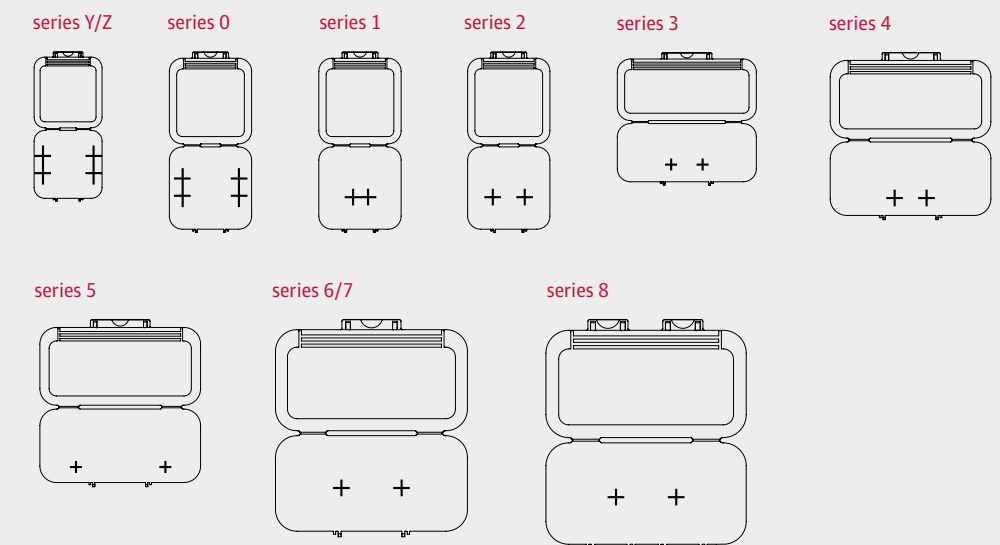

One box, so many possibilities. From micro tools to spade drill inserts – they are all safely packed via the integral clip or center mount

Plastic cases

Keep your products while on the move

Our plastic cases are the ideal protective, sales, and transport packaging solution for a wide variety of products. We offer a smart selection of high-quality plastic cases for various industries and applications.

organized and protected



Rose Case ErgoLine

Plastic cases with top functionality and sales boosting design
more on page 124



Rose Case ProTec

Plastic cases in exclusive design for perfect protection of your products
more on page 130

MK-Case

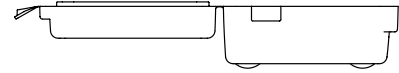

Plastic cases sturdily designed for all-around protection of high-quality milling cutter heads

- secure center fixing screw offers high protection of cutting edge
- extremely strong blown double-wall case
- centering points on base and cover for secure stacking
- built in recess points for easy tool removal
- textured ergonomic carry handle
- durable hinges
- sturdy hinge and lock system
- recessed area on lid for labeling
- available to accommodate various tool diameters
- customized branding available on lid and fixing screw
- built in storage compartment for accessories
- additional adapter rings available to accommodate other arbor holes



 **All-round carefree package – the protection your high-quality milling cutter heads deserve**



PACKAGING
Packed assembled



MATERIAL

- Case shells in Polyethylene (PE)
- Closures, fixing screws and adapter rings in ABS



COLORS

- MKC 50, 80, 160 and 250 case shells in black; MKC 160 and 250 closures in red
- Further colors and color combinations on request



ACCESSORIES

- Adapter

TOOL DIAM.

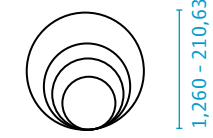

STANDARD COLORS



Product Range

MK-Case

Article	Description	w x h x d	Max. tool diameter Ø 45/90°	Tool holder diam.	max. tool length	PU
F-MK Case 50 01/01	w/ foam insert in cover	4.291x3.898x 2.992in	32, 40, 50, 63	0.625in	1.969in	1000
F-MK Case 80 01/01	w/ foam insert in cover	5.551x5.157x 2.913in	80/100	0.625in	1.969in	30
F-MK Case 160 01/02	adapter Ø 38 and fixing screw	10.709x8.543x 5.118in	160/180	1.26in	2.48in	8
F-MK Case 160 02/02	adapter Ø 40 and fixing screw	10.709x8.543x 5.118in	160/180	1.26in	2.48in	8
F-MK Case 250 01/02	adapter Ø 60 and fixing screw	14.961x12.598x 5.118in	250/270	1.575in	2.48in	6

Accessories for MK-Case 50 and 80

Article	Suitable for	Shank diam.	Shank diam. (in.)	PU
MKC 80 Adapter 19	MK-Case 50/80	0.748in	3/4	4000
MKC 80 Adapter 22	MK-Case 50/80	0.866in		4800
MKC 80 Adapter 25	MK-Case 80	0.984in	1	3000
MKC 80 Adapter 27	MK-Case 80	1.063in		1000

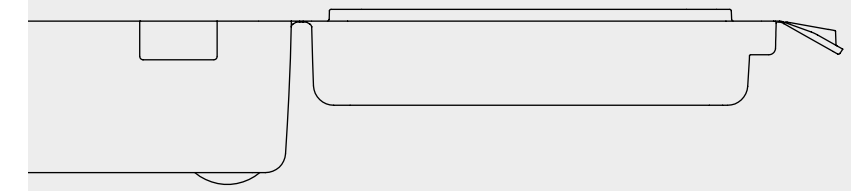

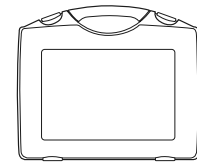

RoseCase ErgoLine

Plastic cases with top functionality and sales boosting design

- modern design gives striking impact
- extremely adaptable to specific market or product requirements through numerous color combinations and various options of interior design – including plain, convoluted, or die-cut foam inserts
- lids and bases can be custom printed or embossed with company logo
- with polished and textured surface label area
- optional transparent lid provides perfect product visibility
- ergonomic handle, optional with 'soft-touch'
- concealed hinges, sturdy integrated feet
- numerous secondary uses
- excellent for stacking and storage



Modern design combined with top functionality – a packaging solution in a class of its own



PACKAGING

Packed assembled



MATERIAL

- Polypropylene (PP)
- Recycled plastic
- Standard version with polished label area



COLORS

- Standard colors "M" & "L": black, red, blue, silver-gray and transparent
- Standard colors "S": transparent
- Closures in black, blue, red, silver-gray or in transparent
- Additional colors and color combinations upon request



ACCESSORIES

- Please inquire for customized foam inserts

INSIDE DEPTHS

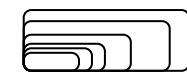

0,709 - 5,197in

INNER DIMENSIONS

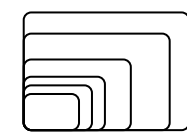

7,087 - 16,575in

STANDARD COLORS



Product Range

RoseCase ErgoLine

Article	Outer width	- height	- depth	Inner width	- height	- depth	PU
RCEL 125 S	7.756in	6.575in	0.906in	7.087in	4.921in	0.709in	45
RCEL 125 SM	7.756in	6.575in	1.378in	7.087in	4.921in	1.181in	30
RCEL 125 M	7.756in	6.575in	1.85in	7.087in	4.921in	1.654in	22
RCEL 155 S	10.827in	9.094in	1.22in	10.039in	6.89in	1.024in	30
RCEL 155 SM	10.827in	9.094in	1.89in	10.039in	6.89in	1.693in	20
RCEL 155 M	10.827in	9.094in	2.559in	10.039in	6.89in	2.362in	15
RCEL 175 S	9.606in	8.15in	1.142in	8.858in	6.102in	0.906in	30
RCEL 175 SM	9.606in	8.15in	1.732in	8.858in	6.102in	1.496in	20
RCEL 175 M	9.606in	8.15in	2.323in	8.858in	6.102in	2.087in	15
RCEL 195 S	12.087in	10.236in	2.165in	11.181in	7.677in	1.89in	40
RCEL 195 SM	12.087in	10.236in	1.378in	11.181in	7.677in	1.181in	25
RCEL 195 M	12.087in	10.236in	2.913in	11.181in	7.677in	2.598in	18
RCEL 220 S	13.622in	11.496in	1.535in	12.598in	8.661in	1.339in	28
RCEL 220 SM	13.622in	11.496in	2.441in	12.598in	8.661in	2.205in	18
RCEL 220 M	13.622in	11.496in	3.307in	12.598in	8.661in	3.071in	13
RCEL 250 M	15.472in	13.032in	3.74in	14.37in	9.843in	3.543in	8
RCEL 290 M	17.953in	15.118in	4.331in	16.575in	11.417in	3.937in	5
RCEL 290 ML	17.953in	15.118in	5in	16.575in	11.417in	4.567in	4
RCEL 290 L	17.953in	15.118in	5.669in	16.575in	11.417in	5.197in	4

first letter stands for cover, second letter stands for base; e.g. SM = cover size S and base size M

Foam inserts for RoseCase ErgoLine

Article	Suitable for	Height	PU	Article	Suitable for	Height	PU
SE Burl RCEL 125/10	RCEL 125	0.394in	1	SE flat foam RCEL 125/10	RCEL 125	0.394in	1
SE Burl RCEL 125/15	RCEL 125	0.591in	1	SE flat foam RCEL 125/15	RCEL 125	0.591in	1
SE Burl RCEL 125/20	RCEL 125	0.787in	1	SE flat foam RCEL 125/20	RCEL 125	0.787in	1
SE Burl RCEL 155/10	RCEL 155	0.394in	1	SE flat foam RCEL 155/10	RCEL 155	0.394in	1
SE Burl RCEL 155/15	RCEL 155	0.591in	1	SE flat foam RCEL 155/15	RCEL 155	0.591in	1
SE Burl RCEL 155/20	RCEL 155	0.787in	1	SE flat foam RCEL 155/20	RCEL 155	0.787in	1
SE Burl RCEL 155/25	RCEL 155	0.984in	1	SE flat foam RCEL 155/25	RCEL 155	0.984in	1
SE Burl RCEL 175/10	RCEL 175	0.394in	1	SE flat foam RCEL 175/10	RCEL 175	0.394in	1
SE Burl RCEL 175/15	RCEL 175	0.591in	1	SE flat foam RCEL 175/15	RCEL 175	0.591in	1
SE Burl RCEL 175/25	RCEL 175	0.984in	1	SE flat foam RCEL 175/30	RCEL 175	1.181in	1
SE Burl RCEL 175/30	RCEL 175	1.181in	1	SE flat foam RCEL 195/15	RCEL 195	0.591in	1
SE Burl RCEL 195/15	RCEL 195	0.591in	1	SE flat foam RCEL 195/20	RCEL 195	0.787in	1
SE Burl RCEL 195/30	RCEL 195	1.181in	1	SE flat foam RCEL 195/30	RCEL 195	1.181in	1
SE Burl RCEL 195/35	RCEL 195	1.378in	1	SE flat foam RCEL 195/35	RCEL 195	1.378in	1
SE Burl RCEL 220/15	RCEL 220	0.591in	1	SE flat foam RCEL 220/15	RCEL 220	0.591in	1
SE Burl RCEL 220/20	RCEL 220	0.787in	1	SE flat foam RCEL 220/25	RCEL 220	0.984in	1
SE Burl RCEL 220/30	RCEL 220	1.181in	1	SE flat foam RCEL 220/35	RCEL 220	1.378in	1
SE Burl RCEL 220/35	RCEL 220	1.378in	1	SE flat foam RCEL 220/40	RCEL 220	1.575in	1
SE Burl RCEL 220/40	RCEL 220	1.575in	1	SE flat foam RCEL 250/25	RCEL 250	0.984in	1
SE Burl RCEL 250/40	RCEL 250	1.575in	1	SE flat foam RCEL 250/45	RCEL 250	1.772in	1
SE Burl RCEL 250/50	RCEL 250	1.969in	1	SE flat foam RCEL 290/50	RCEL 290	1.969in	1
SE Burl RCEL 290/40	RCEL 290	1.575in	1	SE flat foam RCEL 290/65	RCEL 290	2.559in	1
SE Burl RCEL 290/50	RCEL 290	1.969in	1	SE flat foam RCEL 290/25	RCEL 290 L	0.984in	1
SE Burl RCEL 290/60	RCEL 290	2.362in	1	SE flat foam RCEL 290/25	RCEL 290 M	0.984in	1

TOUGH.
DUSTPROOF.
WATERPROOF.
RELIABLE.

RoseCaseProSecure

Strong cases and boxes for indoor and outdoor use – extremely durable and sturdy. Ideal for protecting high-quality items

- robust due to the extra thick wall (RCPS 290/1, 350, 350 TR)
- waterproof sealing ring in the case lid provides reliable protection against dust and water
- certified according to IP67 (except RCPS 350 TR)
- automatic pressure release valve ensures pressure regulation
- easy to open with double throw latches
- eyelets for padlocking
- sturdy hinges over the complete length
- nylon pins for corrosion protection
- comfortable grip handle
- holes for shoulder strap
- wide range of models with wheels and extendable telescopic handle
- excellent for stacking and storage
- labelling area available
- lid can be custom-printed



 **PACKAGING**
Packed assembled

 **MATERIAL**
- Body and handle: Polypropylene (PP)
- Latches: Nylon
- Sealing ring: Polymer

 **COLORS**
- Black, transparent, orange, green

 **ACCESSORIES**
- Wheels, extendable handle, shoulder strap and lid organizer

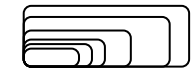
INSIDE DEPTHS
 1,614 - 15,748in

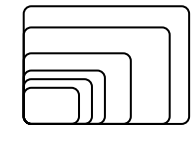
INNER DIMENSIONS
 3,228 - 18,898in
6,181 - 43,307in

STANDARD COLORS

Product Range

Article	Description	With wheels	With extendable handle	Foam in bottom	Foam in cover	Inside dimensions WxHxD (mm)	PU
RCPS 82						157x82x41	12
RCPS 82/2	4 compartments lengthwise					157x82x41	12
F-RCPS 82-R				cubed foam	convoluted foam	157x82x41	12
F-RCPS 82-N				convoluted foam	convoluted foam	157x82x41	12
RCPS 140						212x140x47	12
RCPS 140/2	3-15 compartments					212x140x47	12
F-RCPS 140-R				cubed foam	convoluted foam	212x140x47	12
F-RCPS 140-N				convoluted foam	convoluted foam	212x140x47	12
RCPS 180						235x180x106	4
F-RCPS 180-R				cubed foam	convoluted foam	235x180x106	4
RCPS 180 L						235x180x156	4
F-RCPS 180 L-R				cubed foam	convoluted foam	235x180x156	4
RCPS 195						316x195x53	6
RCPS 195/2	3-15 compartments					316x195x53	6
F-RCPS 195-R				cubed foam	convoluted foam	316x195x53	6
F-RCPS 195-N				convoluted foam	convoluted foam	316x195x53	6
RCPS 195 L						316x195x81	4
RCPS 195/2 L	3 compartments widthwise					316x195x81	4
F-RCPS 195 L-R				cubed foam	convoluted foam	316x195x81	4
RCPS 225						300x225x132	4
F-RCPS 225-R				cubed foam	convoluted foam	300x225x132	4
RCPS 270/1						380 x 270 x 115	2
F-RCPS 270/1-R				cubed foam	convoluted foam	380 x 270 x 115	2
RCPS 270/2						380 x 270 x 160	2
F-RCPS 270/2-R				cubed foam	convoluted foam	380 x 270 x 160	2
RCPS 290/1						426x290x159	2
F-RCPS 290/1-R				cubed foam	convoluted foam	426x290x159	2
RCPS 290/1-P	w/ divider insert					426x290x159	2
RCPS 290/1-W	w/ tool insert/lid organizer					426x290x159	2
RCPS 335/1						465x335x125	1
F-RCPS 335/1-R				cubed foam	convoluted foam	465x335x125	1
RCPS 335/2						465x335x220	1
F-RCPS 335/2-R				cubed foam	convoluted foam	465x335x220	1
RCPS 335/2 TR		x	x			465x335x220	1
F-RCPS 335/2 TR-R		x	x	cubed foam	convoluted foam	465x335x220	1
RCPS 350						500x350x194	1
F-RCPS 350-R				cubed foam	convoluted foam	500x350x194	1
RCPS 350-P	iw/ divider insert					500x350x194	1
RCPS 350-W	w/ tool insert/lid organizer					500x350x194	1
RCPS 350 TR		x	x			500x350x194	1
F-RCPS 350 TR-R		x	x	cubed foam	convoluted foam	500x350x194	1
RCPS 350 TR-P	w/ divider insert	x	x			500x350x194	1
RCPS 350 TR-W	w/ tool insert/lid organizer	x	x			500x350x194	1
RCPS 350 L						500x350x280	1
F-RCPS 350 L-R				cubed foam	convoluted foam	500x350x280	1

 Need to store delicate objects safely? You've come to the right place. High security for high-quality items

Product Range



PACKAGING

Packed assembled



MATERIAL

- Body and handle: Polypropylene (PP)
- Latches: Nylon
- Sealing ring: Polymer



COLORS

- Black, transparent, orange



ACCESSORIES

- Wheels, extendable handle, shoulder strap and lid organizer

INSIDE DEPTHS



INNER DIMENSIONS

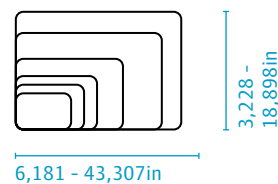

STANDARD COLORS



Article	Description	With wheels	With extendable handle	Foam in bottom	Foam in cover	Inside dimensions WxHxD	PU
RCPS 290/2						520x290x200	1
F-RCPS 290/2-R				cubed foam	convoluted foam	520x290x200	1
RCPS 290/2 TR		x	x			520x290x200	1
F-RCPS 290/2 TR-R		x	x	cubed foam	convoluted foam	520x290x200	1
RCPS 405						538x405x190	1
F-RCPS 405-R				cubed foam	convoluted foam	538x405x190	1
RCPS 405 TR		x	x			538x405x190	1
F-RCPS 405 TR-R		x	x	cubed foam	convoluted foam	538x405x190	1
RCPS 405 L						538x405x245	1
F-RCPS 405 L-R				cubed foam	convoluted foam	538x405x245	1
RCPS 405 L-TR		x	x			538x405x245	1
F-RCPS 405 L TR-R		x	x	cubed foam	convoluted foam	538x405x245	1
RCPS 615						615x615x360	1
F-RCPS 615-R				cubed foam	convoluted foam	615x615x360	1
RCPS 615 TR		x	x			615x615x360	1
F-RCPS 615 TR-R		x	x	cubed foam	convoluted foam	615x615x360	1
RCPS 460		x				620x460x250	1
F-RCPS 460-R		x		cubed foam	convoluted foam	620x460x250	1
RCPS 460 TR		x	x			620x460x250	1
F-RCPS 460 TR-R		x	x	cubed foam	convoluted foam	620x460x250	1
RCPS 460 L		x				620x460x340	1
F-RCPS 460 L-R		x		cubed foam	convoluted foam	620x460x340	1
RCPS 460 L-TR		x	x			620x460x340	1
F-RCPS 460 L TR-R		x	x	cubed foam	convoluted foam	620x460x340	1
RCPS 480		x				750x480x280	1
F-RCPS 480-R		x		cubed foam	convoluted foam	750x480x280	1
RCPS 480 L		x				750x480x400	1
F-RCPS 480 L-R		x		cubed foam	convoluted foam	750x480x400	1
RCPS 370						800x370x140	1
F-RCPS 370-R				cubed foam	convoluted foam	800x370x140	1
F-RCPS 370-N		x		convoluted foam	convoluted foam	800x370x140	1
RCPS 370 L		x				1100x370x140	1
F-RCPS 370 L-R		x		cubed foam	convoluted foam	1100x370x140	1
F-RCPS 370 L-N		x		convoluted foam	convoluted foam	1100x370x140	1

Accessories

Article	Description	Suitable for	Outer width	Outer height	Outer depth	PU
RCPS 1000	wheels & extendable handle	RCPS 290/2	530mm	170mm	20mm	1
RCPS 1001	wheels & extendable handle	RCPS 405, 405L	530mm	170mm	20mm	1
RCPS 1002	extendable handle	RCPS 460, 460L	580mm	170mm	20mm	1
RCPS 1003	wheel set	RCPS 290/2, 405, 405L				1
RCPS 1004	shoulder strap	RCPS 290/1, 350, 350 TR	1500mm	30mm	1mm	1
RCPS 1005	lid organizer	RCPS 290/1	410mm	270mm	60mm	1
RCPS 1006	lid organizer	RCPS 350, 350 TR	475mm	330mm	60mm	1

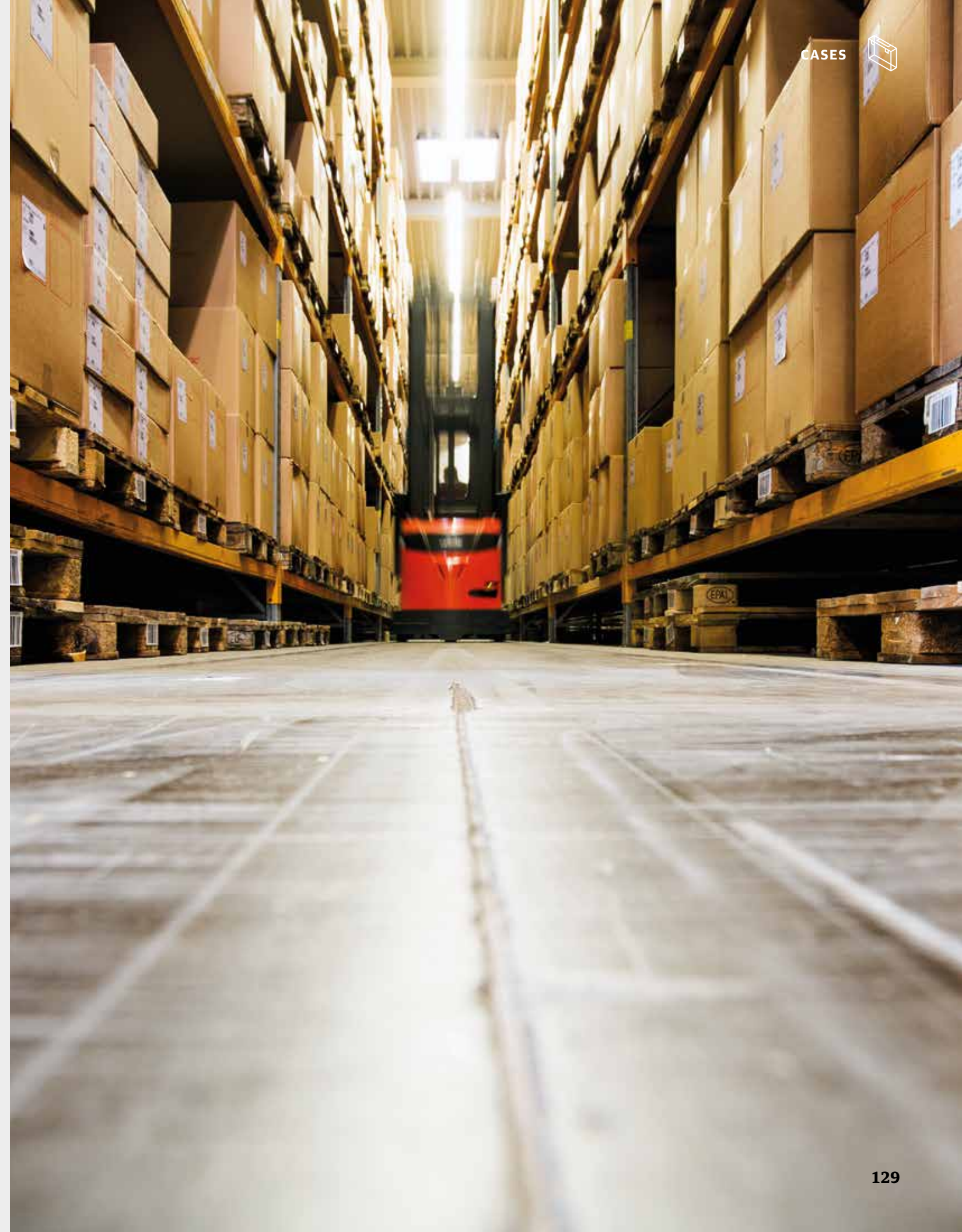

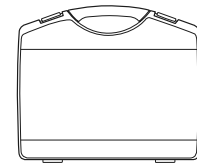

RoseCase ProTec

Exclusive plastic case designed to perfectly protect your product

- top quality and technically designed case prevents case shells from bending or twisting
- optional transparent lid provides perfect product visibility
- with polished and textured surface label area
- strong and durable 180° opening closures
- concealed hinges and sturdy, cleverly integrated feet
- extremely adaptable to specific market or product requirements through numerous color combinations and various options of interior design – including plain, convoluted, or die-cut foam inserts
- lids and bases can be custom printed or embossed with company logo
- sturdy and reusable; excellent for stacking and storage



All in one (case) – maximum protection with an appealing product presentation



PACKAGING

Packed assembled



MATERIAL

- Polypropylene (PP)
- Recycled plastic
- Standard version with polished label area



COLORS

- Standard colors: cover/base in black and transparent; closures in black and red
- RCPT 105: cover with integrated closures; color of closures corresponds to the color of the cover
- Additional colors and color combinations upon request



ACCESSORIES

- Please inquire for customized foam inserts

INNER DEPTHS

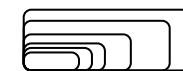

1,378 - 6,142in

INNER DIMENSIONS

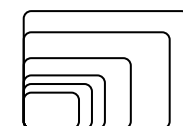

6,890 - 17,087in

STANDARD COLORS



Product Range

RoseCase ProTec

Article	Outer width	- height	- depth	Inner width	- height	- depth	PU
RCPT 105 M	7.362in	5.63in	1.654in	6.89in	4.134in	1.378in	28
RCPT 136 M	9.449in	7.205in	1.89in	8.976in	5.354in	1.654in	24
RCPT 175 M	10.827in	8.858in	3.307in	10.276in	6.89in	3.031in	9
RCPT 161 L	10.315in	8.268in	2.835in	9.606in	6.339in	2.598in	10
RCPT 222 S	13.307in	10.748in	3.307in	12.835in	8.74in	3.031in	12
RCPT 222 SM	13.307in	10.748in	4.843in	12.835in	8.74in	4.567in	8
RCPT 222 M	13.307in	10.748in	6.417in	12.835in	8.74in	6.142in	6
RCPT 237 M	15.551in	11.614in	4.213in	15.039in	9.331in	3.937in	5
RCPT 296 M	17.953in	14.055in	5.512in	17.087in	11.654in	5.197in	4

Foam inserts for RoseCase ProTec

Article	Shape	Suitable for	Outer height	PU
SE Burl RCPT 105/10	convoluted foam	RCPT 105	0.394in	1
SE Burl RCPT 105/15	convoluted foam	RCPT 105	0.591in	1
SE Burl RCPT 105/20	convoluted foam	RCPT 105	0.787in	1
SE Burl RCPT 136/20	convoluted foam	RCPT 136	0.787in	1
SE Burl RCPT 161/30	convoluted foam	RCPT 161	1.181in	1
SE Burl RCPT 175/35	convoluted foam	RCPT 175	1.378in	1
SE Burl RCPT 175/40	convoluted foam	RCPT 175	1.575in	1
SE Burl RCPT 222/25	convoluted foam	RCPT 222	0.984in	1
SE Burl RCPT 222/35	convoluted foam	RCPT 222	1.378in	1
SE Burl RCPT 222/40	convoluted foam	RCPT 222	1.575in	1
SE Burl RCPT 222/50	convoluted foam	RCPT 222	1.969in	1
SE Burl RCPT 222/60	convoluted foam	RCPT 222	1.969in	1
SE Burl RCPT 237/50	convoluted foam	RCPT 237	1.969in	1
SE Burl RCPT 296/25	convoluted foam	RCPT 296	0.984in	1
SE Burl RCPT 296/40	convoluted foam	RCPT 296	1.575in	1
SE Burl RCPT 296/60	convoluted foam	RCPT 296	2.362in	1
SE Flat foam RCPT 105/10	flat foam	RCPT 105	0.394in	1
SE Flat foam RCPT 105/20	flat foam	RCPT 105	0.787in	1
SE Flat foam RCPT 136/15	flat foam	RCPT 136	0.591in	1
SE Flat foam RCPT 136/20	flat foam	RCPT 136	0.787in	1
SE Flat foam RCPT 161/15	flat foam	RCPT 161	0.591in	1
SE Flat foam RCPT 161/30	flat foam	RCPT 161	1.181in	1
SE Flat foam RCPT 175/25	flat foam	RCPT 175	0.984in	1
SE Flat foam RCPT 175/35	flat foam	RCPT 175	1.378in	1
SE Flat foam RCPT 222/20	flat foam	RCPT 222	0.787in	1
SE Flat foam RCPT 222/35	flat foam	RCPT 222	1.378in	1
SE Flat foam RCPT 222/50	flat foam	RCPT 222	1.969in	1
SE Flat foam RCPT 222/75	flat foam	RCPT 222	2.953in	1
SE Flat foam RCPT 237/35	flat foam	RCPT 237	1.378in	1
SE Flat foam RCPT 237/50	flat foam	RCPT 237	1.969in	1
SE Flat foam RCPT 296/25	flat foam	RCPT 296	0.984in	1
SE Flat foam RCPT 296/40	flat foam	RCPT 296	1.575in	1
SE Flat foam RCPT 296/60	flat foam	RCPT 296	2.362in	1



RoseCase RCB and RCS

Two universally useful cases – the extra-sturdy RoseCase RCB in XXL format and the lightweight RoseCase RCS with space-saving folding handle

RoseCase RCB 1

- the XXL case version with more space
- extremely strong blown double-wall case
- sturdy hinge and lock system



1

RoseCase RCS 2

- universal applications
- with functional snap-down handle
- light but strong



2

Capacious and robust or shallower and extra light – these all-rounders are beyond versatile



PACKAGING

Packed assembled



MATERIAL

- 1 **RoseCase RCB**
 - Polyethylene (PE)
- 2 **RoseCase RCS**
 - Polypropylene (PP)
 - Recycled plastic



COLORS

- 1 **RoseCase RCB**
 - Available in various attractive standard colors – please inquire
- 2 **RoseCase RCS**
 - Standard colors in black, red, blue and transparent

INNER DEPTHS

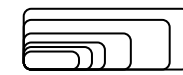

- 1 7,087 - 8,031in
- 2 1,260 and 1,378in

INNER DIMENSIONS

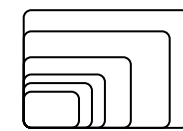

- 1 8,465 - 12,992in
- 2 4,134 and 8,661in

- 1 13,386 - 19,291in
- 2 4,134 and 5,827in

STANDARD COLORS



Product Range

1 RoseCase RCB

Article	Outer width	- height	- depth	Inner width	- height	- depth	PU
RCB 01	15.748in	12.795in	7.874in	13.386in	8.465in	7.087in	1
RCB 02	18.898in	15.354in	7.874in	16.142in	10.63in	7.087in	1
RCB 03	22.047in	17.717in	8.661in	19.291in	12.992in	7.874in	1
RCB 04	19.291in	15.748in	9.252in	16.142in	11.024in	8.032in	1

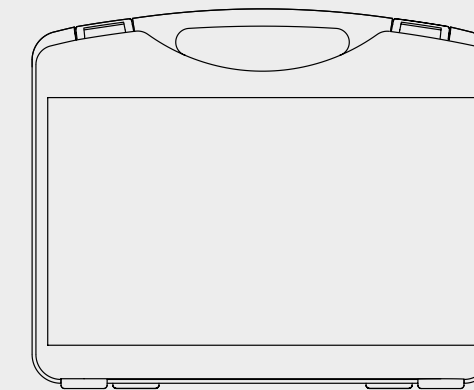

2 RoseCase RCS

Article	Outer width	- height	- depth	Inner width	- height	- depth	PU
RCS 1136 K	6.102in	5.236in	1.417in	5.827in	4.134in	1.26in	134
RCS 1240 K	4.449in	9.803in	1.575in	4.134in	8.661in	1.378in	84

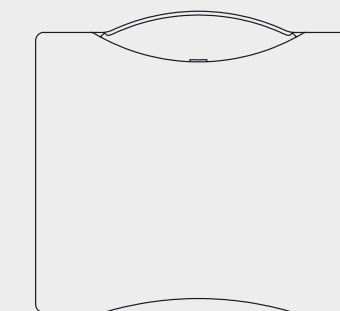

RoseCassette

Ergonomically optimized plastic assortment box with removable inserts. Ideal for drills, screws and small parts

- high transparency lid offers optimum visibility to contents
- user-friendly, easy grasp features on both sides
- 90° swiveling, retractable handle; additional safety lock prevents accidental opening
- extremely adaptable to specific market or product requirements due to a variety of color combinations and various interior design options – including convoluted or plain foam and die-cut foam inserts
- excellent scope for printing and labeling, product information can be printed in full view on the cassette lid
- universal application
- excellent for stacking and storage
- numerous secondary uses



This assortment box with a highly transparent lid is ideal for drills, screws, and small parts – so you can always see what's what (and where)



PACKAGING
Packed assembled



MATERIAL

- Cassette: Polystyrene (PS) / ABS
- Closures: Polypropylene (PP)
- Handle: Polyethylene (PE)
- Thermoformed insert: Polystyrene (PS)



COLORS

- Base in black, cover in clear, closures and handle in red
- Colors and color combinations on request



ACCESSORIES

- StorePack (see page 164)

INNER DEPTH

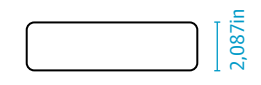

INNER DIMENSION

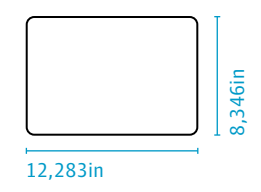

STANDARD COLORS



Product Range

RoseCassette

Article	Outer width	- height	- depth	Inner width	- height	- depth	PU
CR 212/02 K 006	12.835in	9.488in	2.244in	12.283in	8.346in	2.087in	11

Thermoformed inserts for RoseCassette

Article	Description	Suitable for	Number of compartments	Compartment size	PU
INS CR 212/1 BAS	thermoformed base	170 pcs. HSS/ Ø 1-10x0.5mm	0		50
INS CR 212/1 COV	thermoformed cover	170 pcs. HSS drills	0		300
INS CR 212/2 BAS	thermoformed insert	universal applications	4	5,354x3,386x1,929	28
INS CR 212/3 BAS	thermoformed insert	universal applications	8	2,402x3,386x1,929	28
INS CR 212/4 BAS	thermoformed insert	universal applications	12	2,402x2,087x1,929	28
INS CR 212/5 BAS	thermoformed insert	universal applications	16	2,402x1,496x1,929	28
INS CR 212/6 BAS	thermoformed insert	universal applications	18	2,087x1,496x1,929	28
INS CR 212/7 BAS	thermoformed insert	universal applications	24	1,496x1,496x1,929	28

UniCase

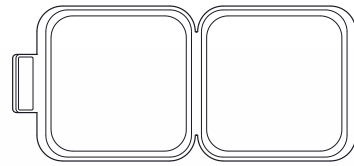

**Plastic cases in sturdy double-wall design.
Ideal for high quality tools and special parts**

- interior design options include convoluted or plain foam, or die-cut foam inserts, according to customer specification
- double-wall design offers optimum protection for the content
- version plain – without compartments possible
- version with center post possible



PACKAGING
Packed assembled



MATERIAL
- Polyethylene (PE)



COLORS
- In black or in various attractive standard colors



ACCESSORIES
- Foam inserts (see page 180)

INNER DEPTHS

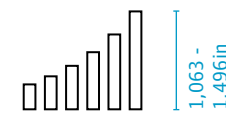

INNER DIMENSIONS

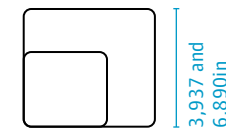

STANDARD COLORS



Product Range

Article	Description	Inner width	Inner height	Inner depth	PU
UC 100x27/3	w/ center spigot Ø 22+recess	3.937in	3.937in	1.063in	64
UC 100x32/1	w/o compartment	3.937in	3.937in	1.26in	51
UC 100x32/2	w/ center spigot Ø 22	3.937in	3.937in	1.26in	51
UC 100x32/4	w/ center spigot Ø 25.4	3.937in	3.937in	1.26in	51
UC 175x35/3	w/ center spigot Ø 22+recess	6.89in	6.89in	1.378in	36
UC 175x38/1	w/o compartment	6.89in	6.89in	1.496in	36
UC 175x38/2	w/ center spigot Ø 22	6.89in	6.89in	1.496in	36
UC 175x38/4	w/ center spigot Ø 29.5	6.89in	6.89in	1.496in	36
UC 175x38/5	w/ center spigot Ø 49.5	6.89in	6.89in	1.496in	36

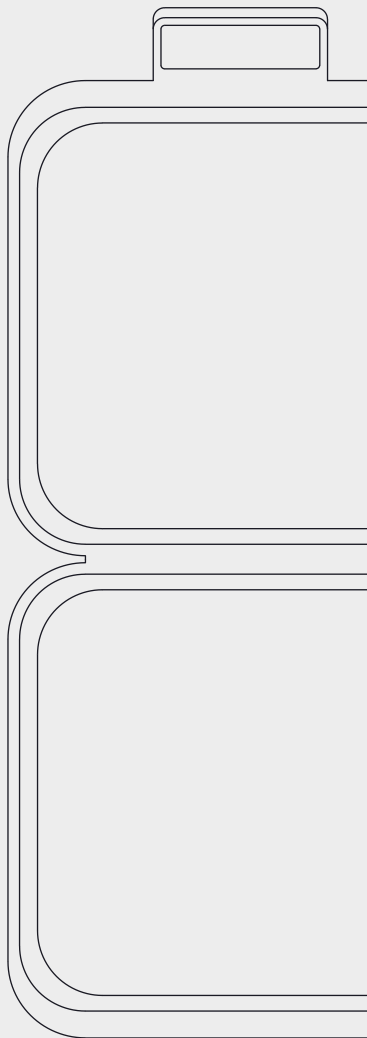

Safety first – this double-walled plastic case perfectly protects high-quality tools and special parts

Plastic cassettes

Stylish, safe, and sturdy cassettes.

rose plastic is your first port of call for secure and cost-effective packaging for drill sets. We carry an extensive standard range of plastic cassettes that are compatible with a large number of popular drill sets.



GripBox

...has a firm grip on your tools!
Plastic drill cassettes for drill bit sets
more on page 150



FACassette

Plastic drill cassettes for all types of drill bit sets
more on page 140

RoseBox

High-quality plastic cassettes in modern design. Ideal for all kinds of drill bit sets, precision tools, shank tools, special tool sets and spare parts
more on page 152

FA Cassette

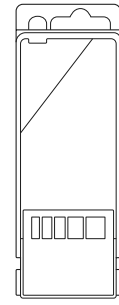

Plastic drill cassettes for all types of drill bit sets (HSS / Masonry / SDS / Wood drills etc.)

- four individual parts: cover, base, insert and safety pin
- clear hinged cover
- secure anti-theft closure with safety pin
- printing available on cover, insert and base



PACKAGING
Cassette packed assembled; safety pin packed separately in plastic bag



MATERIAL
- Polystyrene (PS)



COLORS
- Cover in clear; base, insert and safety pin in color

DIMENSIONS

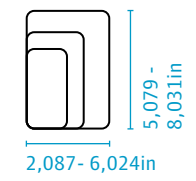

STANDARD COLORS



Product Range

Article	Suitable for	Holding devices	Index design	Outer length	Outer width	Outer depth	PU
FA 01-314	HSS drills	6	2/3/4/5/6/8mm	6.26in	2.087in	0.669in	210
FA 01-318	Masonry drills	5	3/4/5/6/8mm	6.26in	2.087in	0.669in	210
FA 01-320	Masonry drills	4	4/5/6/7mm	6.26in	2.087in	0.669in	210
FA 01-323	Masonry drills	5	5/6/7/8/10mm	6.26in	2.087in	0.669in	210
FA 01-325	Masonry drills	4	4/5/6/8mm	6.26in	2.087in	0.669in	210
FA 01-326	Masonry drills	5	4/5/6/7/8mm	6.26in	2.087in	0.669in	210
FA 01-327	Masonry drills	5	4/5/6/8/10mm	6.26in	2.087in	0.669in	210
FA 01-328	Masonry drills	4	5/6/8/10mm	6.26in	2.087in	0.669in	210
FA 01-334	Wood drills	5	4/5/6/8/10mm	6.26in	2.087in	0.669in	210
FA 01-340	Masonry drills	4	5/7/8/10mm	6.26in	2.087in	0.669in	210
FA 01-345	SDS drills	4	5/7/8/10mm	6.26in	2.087in	0.669in	210
FA 01-348	SDS drills	3	5/6/8x110mm	6.26in	2.087in	0.669in	210
FA 01-349	SDS drills	3	6/8/10x110mm	6.26in	2.087in	0.669in	210
FA 01-354	Masonry drills	5	5/6/7/8/10mm	6.26in	2.087in	0.669in	210
FA 01-355	Masonry drills	4	5/6/8/10mm	6.26in	2.087in	0.669in	210
FA 01-358	SDS drills	4	5/6/8/10x110mm	6.26in	2.087in	0.669in	210
FA 01-380	Masonry drills	5	5/32-3/16-1/4-5/16-3/8"	6.26in	2.087in	0.669in	210
FA 01-395	HSS drills	5	4/5/6/8/10mm	6.26in	2.087in	0.669in	210
FA 01-396	Masonry drills	5	1/8-3/16-1/4-5/16-3/8"	6.26in	2.087in	0.669in	210
FA 01-398	HSS drills	6	3/32-1/8-5/32-3/16-1/4-5/16"	6.26in	2.087in	0.669in	210
FA 01-439	Masonry drills	4	5/6/6/8mm	6.26in	2.087in	0.669in	210
FA 01-470	Wood drills	5	3/5/6/9/10mm	6.26in	2.087in	0.669in	210
FA 01-480	Masonry drills	5	3.5/4/4.8/6/6.4mm	6.26in	2.087in	0.669in	210
FA 01-481	Masonry drills	5	3.5/4/4.8/6/6.4mm	6.26in	2.087in	0.669in	210
FA 01-526	HSS drills	5	4/5/6/7/8mm	6.26in	2.087in	0.669in	210
FA 01-527	Masonry drills	5	4/5/6/8/10mm, w/o length stop	6.26in	2.087in	0.669in	210
FA 01-605	Masonry drills	5	4/5/6/8/10mm	6.26in	2.087in	0.669in	210
FA 01-606	HSS drills	5	2/3/4/5/6mm	6.26in	2.087in	0.669in	210
FA 01-703	Screwdriver	5	No. 3-8	6.26in	2.087in	0.669in	210
FA 01-747	Wood drills	5	1/8-3/16-1/4-5/16-3/8"	6.26in	2.087in	0.669in	210
FA 01-793	HSS drills	5	4/5/6/8/10mm	6.26in	2.087in	0.669in	210
FA 01-797	HSS drills	6	2/3/4/5/6mm + 1 center punch	6.26in	2.087in	0.669in	210
FA 01-816	Masonry drills	5	5/6/6/8/10mm	6.26in	2.087in	0.669in	210
FA 01-835	Masonry drills	4	4/6/8/10mm	6.26in	2.087in	0.669in	210
FA 01-843	Jigsaw blades	5		6.26in	2.087in	0.669in	210
FA 01-844	Jigsaw blades	6		6.26in	2.087in	0.669in	210
FA 01-846	Jigsaw blades	5	max. 125mm + 1 drill max. Ø8mm	6.26in	2.087in	0.669in	210
FA 01-852	Masonry drills	5	5/5.5/6/6.5/7mm	6.26in	2.087in	0.669in	210
FA 01-853	Masonry drills	5	4/5/5.5/6.5/7mm	6.26in	2.087in	0.669in	210
FA 01-866	Masonry drills	4	5.5/6/8/10mm	6.26in	2.087in	0.669in	210
FA 01-885	Screwdriver	5	No. 1-5	6.26in	2.087in	0.669in	210
FA 01-894	Jigsaw blades	6	2xmetall + 4xwood B&D-shank	6.26in	2.087in	0.669in	210
FA 01-896	Jigsaw blades	6	2xmetall + 4xwood Bosch-shank	6.26in	2.087in	0.669in	210
FA 01-938	Wood drills	5	3/4/5/6/8mm	6.26in	2.087in	0.669in	210
FA 02-312	HSS drills	10	1.0-10.0x1.0mm	6.26in	3.898in	0.669in	130
FA 02-313	HSS drills	13	2.0-8.0x0.5mm	6.26in	3.898in	0.669in	130
FA 02-319	Masonry drills	8	3/4/5/6/7/8/9/10mm	6.26in	3.898in	0.669in	130
FA 02-323	Masonry / Wood	9	3/4/4/5/5/6/6/8/8mm	6.26in	3.898in	0.669in	130
FA 02-329	HSS/Masonry	9	3/4/5/6/8mm + 4/5/6/8mm	6.26in	3.898in	0.669in	130

**Need more options?
The secure anti-theft closure with safety pin ensures your drill sets are optimally protected**

Product Range

 **PACKAGING**
Cassette packed assembled;
safety pin packed sepearatly
in plastic bag

 **MATERIAL**
- Polystyrene (PS)

 **COLOR**
- Cover in clear;
base, insert and
safety pin in color

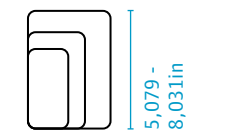
DIMENSION

2,087- 6,024in

STANDARD COLOR

Article	Suitable for	Holding devices	Index design	Outer length	Outer width	Outer depth	PU
FA 02-330	HSS/Masonry	8	4/5/6/8mm + 4/5/6/8mm	6.26in	3.898in	0.669in	130
FA 02-331	HSS/Masonry/Wood	9	4/6/8+4/6/8+4/6/8mm	6.26in	3.898in	0.669in	130
FA 02-332	HSS/Masonry/Wood	9	5/6/8+5/6/8+5/6/8mm	6.26in	3.898in	0.669in	130
FA 02-333	Wood drills	8	3/4/5/6/7/8/9/10mm	6.26in	3.898in	0.669in	130
FA 02-338	Wood drills	7	3/4/5/6/8/10mm + countersink	6.26in	3.898in	0.669in	130
FA 02-339	HSS/Masonry/Wood	9	3/4/5/5/5/6/6/8/8mm	6.26in	3.898in	0.669in	130
FA 02-347	Masonry drills	8	3/4/5/5.5/6/6.5/8/10mm	6.26in	3.898in	0.669in	130
FA 02-351	Masonry / Wood	9	3/4/4/5/5/6/7/8/8mm	6.26in	3.898in	0.669in	130
FA 02-352	HSS/Masonry	9	3/4/4/5/5/6/7/8/8mm	6.26in	3.898in	0.669in	130
FA 02-353	HSS/Masonry/Wood	9	5/5/5/6/6/7/8/8/8mm	6.26in	3.898in	0.669in	130
FA 02-359	Masonry drills	7	3/4/5/6/8/9/10mm	6.26in	3.898in	0.669in	130
FA 02-360	Masonry drills	8	3/4/5/6/8/9/10/12mm	6.26in	3.898in	0.669in	130
FA 02-361	Masonry drills	7	4/5/6/7/8/9/10mm	6.26in	3.898in	0.669in	130
FA 02-362	Masonry drills	7	3/4/5/6/7/8/10mm	6.26in	3.898in	0.669in	130
FA 02-363	Masonry drills	8	3/4/5/6/6/8/8/10mm	6.26in	3.898in	0.669in	130
FA 02-364	Masonry drills	7	3/4/5/6/7/8/10mm	6.26in	3.898in	0.669in	130
FA 02-366	Masonry drills	8	4/5/5.5/6/6.5/7/8/10mm	6.26in	3.898in	0.669in	130
FA 02-379	Masonry drills	8	4/5/5.5/6/6.5/7/8/10mm	6.26in	3.898in	0.669in	130
FA 02-391	HSS drills	11	1/16"-3/8"x1/32"	6.26in	3.898in	0.669in	130
FA 02-440	Masonry drills	7	3/4/5/6/7/8/10mm	6.26in	3.898in	0.669in	130
FA 02-604	Machine taps	7	M3/M4/M5/M6 /M8/M10/M12	6.26in	3.898in	0.669in	130
FA 02-794	HSS drills	8	3/4/5/6/7/8/9/10mm	6.26in	3.898in	0.669in	130
FA 02-833	Masonry drills	7	3/4/5/6/6/8/10mm	6.26in	3.898in	0.669in	130
FA 02-868	Torx	8	9/10/15/20 /25/27/30/40mm	6.26in	3.898in	0.669in	130
FA 02-939	Wood drills	7	3/4/5/6/7/8/10mm	6.26in	3.898in	0.669in	130
FA 02-950	Jigsaw blades	10		6.26in	3.898in	0.669in	130
FA 02-953	Jigsaw blades	10		6.26in	3.898in	0.669in	130
FA 02-9953	Jigsaw blades	10		6.26in	3.898in	0.669in	130
FA 03-335	HSS drills	7	1.5/2/3/4/5/5.5/6mm	5.079in	3.031in	0.512in	220
FA 03-336	HSS drills	13	1.5-6.5x0.5mm + 3.3mm + 4.2mm	5.079in	3.031in	0.512in	220
FA 03-337	HSS drills	13	1.5-6.5x0.5mm + 3.2mm + 4.8mm	5.079in	3.031in	0.512in	220
FA 03-392	HSS drills	7	1/16-1/4"x1/32"	5.079in	3.031in	0.512in	220
FA 03-393	HSS drills	10	1/16-5/32x1/64+3/16-1/4"x1/32"	5.079in	3.031in	0.512in	220
FA 03-394	HSS drills	13	1/16"-1/4"x1/64"	5.079in	3.031in	0.512in	220
FA 03-435	HSS drills	10	1.5-6.0x0.5mm	5.079in	3.031in	0.512in	220
FA 03-436	HSS drills	10	1.5-3x0.5+3.2+3.5+4-5x0.5+6mm	5.079in	3.031in	0.512in	220
FA 03-490	HSS drills	7	2/2.5/3/4/5/6/6.5mm	5.079in	3.031in	0.512in	220
FA 03-536	HSS drills	13	1.5-6.5x0.5mm + 3.3mm + 4.2mm	5.079in	3.031in	0.512in	220
FA 03-537	HSS drills	13	1.5-6.5x0.5mm + 3.2mm + 4.8mm	5.079in	3.031in	0.512in	220
FA 03-592	HSS drills	7	1/16-1/4"x1/32"	5.079in	3.031in	0.512in	220
FA 03-594	HSS drills	13	1/16"-1/4"x1/64"	5.079in	3.031in	0.512in	220
FA 03-954	Jigsaw blades	7		5.079in	3.031in	0.512in	220
FA 03-956	Jigsaw blades	7	T-shank	5.079in	3.031in	0.512in	220
FA 04-311	HSS drills	19	1.0-10.0x0.5mm	6.26in	6.024in	0.669in	80
FA 04-390	HSS drills	21	1/16"-3/8"x1/64"	6.26in	6.024in	0.669in	80
FA 04-799	HSS/Masonry/Wood	23	2-6/8+4-6/8/10+3-6/8/10+6 Bits	6.26in	6.024in	0.669in	80
FA 04-915	HSS/Masonry/Wood	15	4/5/6/8/10mm	6.26in	6.024in	0.669in	80
FA 04-8886	HSS drills	20	1/16"-3/8"	6.26in	6.024in	0.669in	80
FA 05-401	SDS drills	5	5/5.5x110mm + 5.5/8/10x160mm	8.032in	3.898in	0.669in	130

Product Range

 **PACKAGING**
Cassette packed assembled;
safety pin packed sepearatly
in plastic bag

 **MATERIAL**
- Polystyrene (PS)

 **COLORS**
- Cover in clear;
base, insert and
safety pin in color

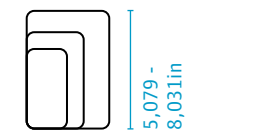
DIMENSIONS

2,087- 6,024in

STANDARD COLORS

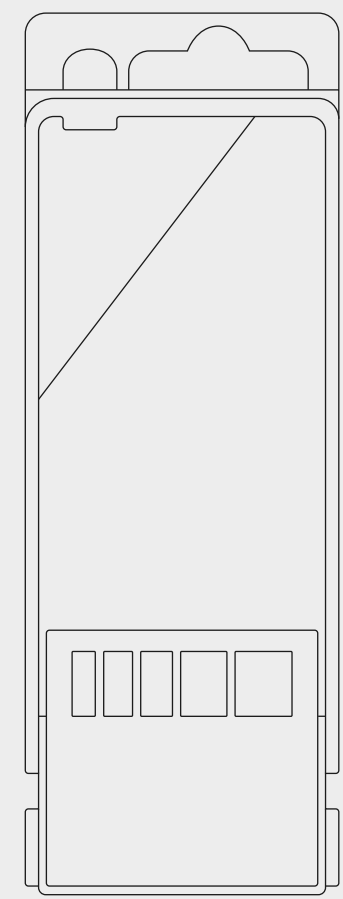
Article	Suitable for	Holding devices	Index design	Outer length	Outer width	Outer depth	PU
FA 05-402	SDS drills	5	5/7x110mm + 7/8/10x160mm	8.032in	3.898in	0.669in	130
FA 05-403	SDS drills	5	5/5.5x110mm + 6/7/8x160mm	8.032in	3.898in	0.669in	130
FA 05-404	SDS drills	5	4.8/6.4/10.5 /12.5/14.3mm	8.032in	3.898in	0.669in	130
FA 05-405	SDS drills	5	5/6x110mm + 6/8/10x160mm	8.032in	3.898in	0.669in	130
FA 05-407	SDS drills	5	5/6x110mm + 8/10/12x160mm	8.032in	3.898in	0.669in	130
FA 05-412	SDS drills	6	5/6/8x110mm + 6/8/10x160mm	8.032in	3.898in	0.669in	130
FA 05-415	SDS drills	5	5/6/8x110mm + 6/8x160mm	8.032in	3.898in	0.669in	130
FA 05-432	Masonry drills	8	3/4/5/6/6/8/10/12mm	8.032in	3.898in	0.669in	130
FA 05-434	Masonry drills	7	4/5/6/7/8/10/12mm	8.032in	3.898in	0.669in	130
FA 06-548	SDS drills	4	5/6x110mm + 6/8x160mm	8.032in	2.087in	0.669in	210
FA 06-558	SDS drills	4	5/6x110mm + 8/10x160mm	8.032in	2.087in	0.669in	210
FA 06-559	SDS drills	4	5x110mm + 6/8/10x160mm	8.032in	2.087in	0.669in	210
FA 06-568	SDS drills	4	5/6/8/10x160mm	8.032in	2.087in	0.669in	210
FA 06-569	SDS drills	3	10.5/12.5/14.3x160mm	8.032in	2.087in	0.669in	210
FA 06-570	SDS drills	4	6/8/10/12x160mm	8.032in	2.087in	0.669in	210
FA 06-571	SDS drills	4	5.5/6/7/8x160mm	8.032in	2.087in	0.669in	210
FA 07-300	Bits+Magnetic holder	16	15 bits+bit holder	6.319in	2.677in	0.669in	180



FB Cassette

Plastic drill cassettes for all types of drill bit sets
(HSS / Masonry / SDS / Wood drills etc.)

- four individual parts: cover, base, insert and safety pin
- clear hinged cover
- secure anti-theft closure with safety pin
- printing available on cover, insert and back

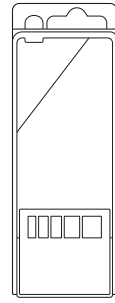

PACKAGING

Cassette packed assembled;
safety pin packed separately
in plastic bag



MATERIAL

— Polystyrene (PS)



COLORS

— Cover in clear;
base, insert and
safety pin in color

DIMENSIONS

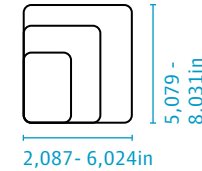

STANDARD COLORS



Product Range

Article	Suitable for	Holding devices	Index design	Outer length	Outer width	Outer depth	PU
FB 01-314	HSS drills	6	2/3/4/5/6/8mm	6.26in	2.087in	0.669in	230
FB 01-316	HSS drills	5	2/3/4/5/6mm (Crown Point)	6.26in	2.087in	0.669in	230
FB 01-320	Masonry drills	4	4/5/5.5/6.5mm	6.26in	2.087in	0.669in	230
FB 01-321	Masonry drills	4	4/5/6/7mm (SpearPoint)	6.26in	2.087in	0.669in	230
FB 01-325	Masonry drills	4	4/5/6/8mm (Point round)	6.26in	2.087in	0.669in	230
FB 01-327	Masonry drills	5	4/5/6/8/10mm	6.26in	2.087in	0.669in	230
FB 01-328	Masonry drills	4	5/6/8/10mm	6.26in	2.087in	0.669in	230
FB 01-334	Wood drills	5	4/5/6/8/10mm	6.26in	2.087in	0.669in	230
FB 01-338	Wood drills	5	4/5/6/8mm+Senker	6.26in	2.087in	0.669in	230
FB 01-340	Diamond drills	5	4/5/6/8/10mm	6.26in	2.087in	0.669in	230
FB 01-395	HSS drills	5	4/5/6/8/10mm	6.26in	2.087in	0.669in	230
FB 01-397	Masonry drills	4	4/5/6/8mm SpearPoint,Hex-Shank	6.26in	2.087in	0.669in	230
FB 01-525	Masonry drills	4	4/5/6/8mm	6.26in	2.087in	0.669in	230
FB 01-804	HSS drills	6	1/16"-5/16"	6.26in	2.087in	0.669in	230
FB 01-938	Wood drills	5	3/4/5/6/8mm	6.26in	2.087in	0.669in	230
FB 02-312	HSS drills	10	1.0-10.0x0.5mm	6.26in	3.898in	0.669in	130
FB 02-313	HSS drills	13	2.0-8.0x0.5mm	6.26in	3.898in	0.669in	130
FB 02-319	Masonry drills	8	3/4/5/6/7/8/9/10mm	6.26in	3.898in	0.669in	130
FB 02-329	HSS/Masonry	9	3/4/5/6/8mm+4/5/6/8mm	6.26in	3.898in	0.669in	130
FB 02-330	HSS/Masonry	8	4/5/6/8mm+4/5/6/8mm	6.26in	3.898in	0.669in	130
FB 02-331	HSS/Masonry/Wood	9	4/6/8+4/6/8+4/6/8mm	6.26in	3.898in	0.669in	130
FB 02-332	HSS/Masonry/Wood	9	5/6/8+5/6/8+5/6/8mm	6.26in	3.898in	0.669in	130
FB 02-333	Wood drills	8	3-10x1.0mm	6.26in	3.898in	0.669in	130
FB 02-350	Masonry drills	7	4/5/6/7/8/9/10mm	6.26in	3.898in	0.669in	130
FB 02-351	Masonry drills	7	4/5/5.5/6/7/8/10mm	6.26in	3.898in	0.669in	130
FB 02-353	Masonry drills	7	3/4/5/6/6/8/10mm	6.26in	3.898in	0.669in	130
FB 02-359	Masonry drills	7	3/4/5/6/8/9/10mm	6.26in	3.898in	0.669in	130
FB 02-362	Masonry drills	8	3/4/5/6/8/9/10/12mm	6.26in	3.898in	0.669in	130
FB 02-939	Wood drills	7	3/4/5/6/7/8/10mm	6.26in	3.898in	0.669in	130
FB 03-336	HSS drills	13	1.5-6.5x0.5mm+3.3mm+4.2mm	5.079in	3.031in	0.512in	220
FB 03-337	HSS drills	13	1.5-6.5x0.5mm+3.2mm+4.8mm	5.079in	3.031in	0.512in	220
FB 03-339	HSS drills	13	1.5-6.5x0.5mm+3.2mm+4.2mm	5.079in	3.031in	0.512in	220
FB 03-343	HSS drills	7	2/2.5/3/3.5/4/5/6mm	5.079in	3.031in	0.512in	220
FB 03-392	HSS drills	7	1/16"-1/4"	5.079in	3.031in	0.512in	220
FB 03-393	HSS drills	10	1/16"-1/4"	5.079in	3.031in	0.512in	220
FB 03-394	HSS drills	13	1/16"-1/4"	5.079in	3.031in	0.512in	220
FB 03-802	HSS drills	5	1/16"-1/4"	5.079in	3.031in	0.512in	220
FB 04-311	HSS drills	19	1.0-10.0x0.5mm	6.26in	6.024in	0.669in	80
FB 04-386	HSS drills	20	1/16"-3/8"	6.26in	6.024in	0.669in	80
FB 05-360	SDS drills	4	5/6x110mm+8/10x160mm	8.032in	3.898in	0.669in	160
FB 05-361	SDS drills	4	6/8/10/12x160mm	8.032in	3.898in	0.669in	160
FB 05-365	SDS drills	4	5.5/7/8/10x160mm	8.032in	3.898in	0.669in	160
FB 05-367	SDS drills	4	5/6/8x110mm+10x160mm	8.032in	3.898in	0.669in	160
FB 05-887	SDS drills	4	1/4"-1/2"	8.032in	3.898in	0.669in	160

 Multiple sizes,
one product – the
perfect packaging
solution for drill sets

FNKL Cassette

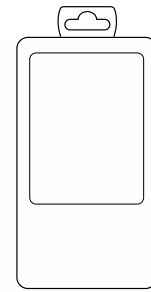

Plastic drill bit cassettes in robust, sturdy design for SDS-drills and pin punches

- four individual parts: cover, base, insert and hanger
- snap-fit holds the tools in place
- integrated anti-theft feature
- printing available on cover



PACKAGING
Packed assembled



MATERIAL
- Polypropylene (PP)



COLORS
- Available in various attractive standard colors and color combinations

USABLE LENGTHS

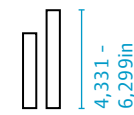

DIMENSION

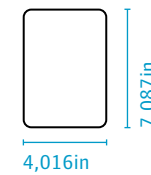

STANDARD COLORS

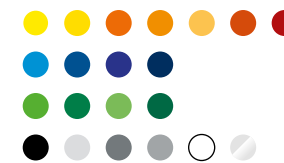

Product Range

Article	Suitable for	Number of holding devices	Usable length fixed	Outer length	Outer width	Outer height	PU
FNKL 1/1	Pin punches	6	6.299in	7.087in	4.016in	0,866in	100
FNKL 1/2	SDS drills	6	6.299in	7.087in	4.016in	0,866in	100
FNKL 1/3	SDS drills	6	4.331in	7.087in	4.016in	0,866in	140
FNKL 2/2	SDS drills	7	6.299in	7.087in	4.016in	0,866in	140
FNKL 2/3	SDS drills	7	4.331in	7.087in	4.016in	0,866in	140

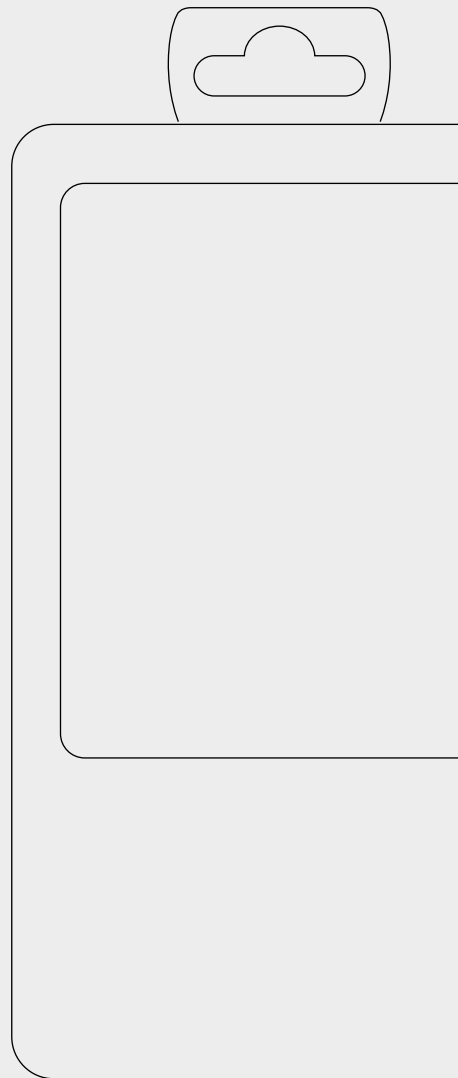

Simple and efficient – no other packaging offers better protection for SDS drills and pin punches

FNSB Cassette

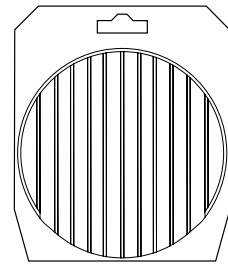

Plastic cassettes with integrated anti-theft feature for jigsaw blade set

- cost-effective packaging solution
- printing available on cover and base
- available in various sizes and versions
- two parts: cover and base



PACKAGING

Base and cover are packed separately in individual cartons



MATERIAL

- Polystyrene (PS)



COLORS

- Cover in clear
- Base in color

DIMENSIONS

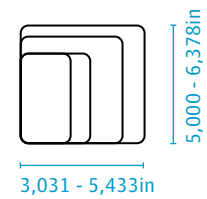

STANDARD COLORS



Product Range

Article	Suitable for	Number of holding devices	Outer length	Outer width	Outer height	PU
FNSB 9666	Jigsaw blades	6	5in	3.465in	0.394in	1000
FNSB 9697	Saw blades max. length 100mm	10	5in	4.016in	0.394in	1000
FNSB 9783	Jigsaw blades (80-125mm)	10	6.378in	5.433in	0.472in	1000
FNSB 9820	Saw blades max. length 100mm	5	5.433in	3.031in	0.354in	1000

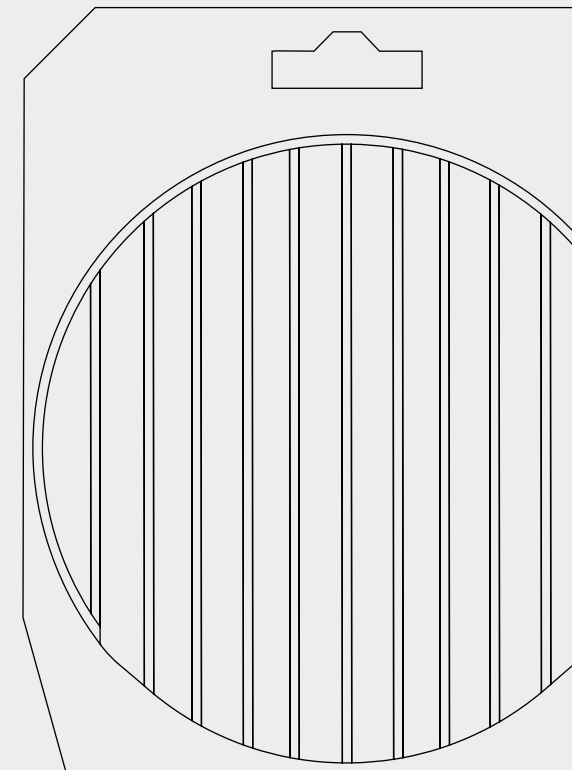

Simple, yet ingenious – this secure packaging ensures your jigsaw blade sets are perfectly protected

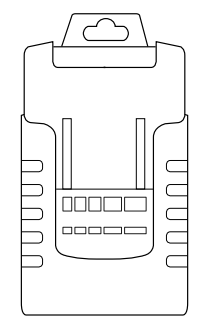

Grip Box

...has a firm grip on your tools! Plastic drill cassettes for drill bit sets (HSS drill sets DIN 338, machine tap sets DIN 371/376 etc.)

- four parts: cover, base, insert and safety pin
- sturdy and modern design with ergonomic body design
- clear cover allows for product visibility
- integral designed hanging loop
- twist off anti-theft locking pin
- cover and base with integral tool stop
- easy, efficient handling
- excellent for stacking and storage



PACKAGING
Cassette packed assembled; safety pin packed separately in plastic bag



MATERIAL
- Base and insert: Polypropylene (PP)
- Cover: Polystyrene (PS)



COLORS
- Cover in clear
- Base, insert and safety pin in color

DIMENSIONS

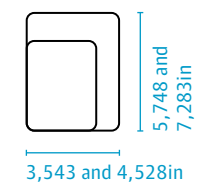

STANDARD COLORS



Product Range

Article	Suitable for	Holding devices	Index design	Standardization	Outer length	Outer width	Outer height	PU
GB 3A 07/01	Machine taps	7	M3-M12	DIN 371/DIN376	5.748in	3.543in	1.457in	70
GB 3A 07/02	HSS drills	7	1/4"3/16"9/64" 1/8"7/64"3/32"		5.748in	3.543in	1.457in	70
GB 3A 07/03	Machine taps	7	M3-M12	JIS	5.748in	3.543in	1.457in	70
GB 3A 14/01	Machine taps	14	M3-M12 +core hole drill	DIN 371/DIN376	5.748in	3.543in	1.457in	70
GB 3A 14/02	HSS drills	14	1.5-6.5x0.5+3.2 +4.8+ holder		5.748in	3.543in	1.457in	70
GB 3A 14/03	HSS drills	14	1/16"-1/4"x1/64"+holder		5.748in	3.543in	1.457in	70
GB 3A 19/01	HSS drills	19	1-10mmx0.5mm	DIN 338	5.748in	3.543in	1.457in	70
GB 3A 20/01	HSS/Masonry/Wood	20	4/5/6/8+HSS1-6.5x0.5		5.748in	3.543in	1.457in	70
GB 3A 21/01	HSS drills	21	1/16"-3/8"x1/64"	DIN 338	5.748in	3.543in	1.457in	70
GB 4A 07/01	SDS drills	7	5/6/8x110+ 6/8/10/12x160		7.283in	4.528in	1.57in	50
GB 4B 25/01	HSS drills	25	1-13mmx0.5mm	DIN 338	7.283in	4.528in	2.48in	30
GB 4B 25/02	HSS drills	25	1-13mmx0.5mm	DIN 338	7.283in	4.528in	2.48in	30
GB 4B 29/01	HSS drills	29	1/16"-1/2"x1/64"	DIN 338	7.283in	4.528in	2.48in	30

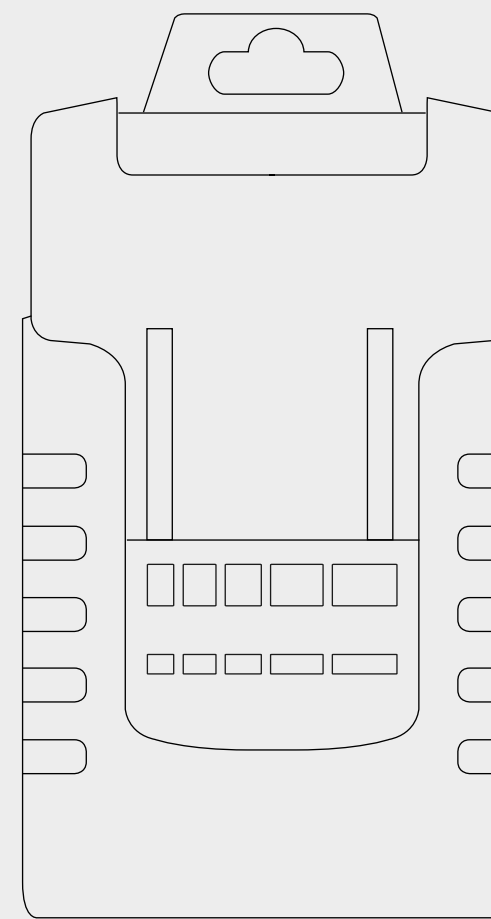

Everything under control – this packaging solution not only perfectly protects drill sets, but also guarantees a stunning appearance thanks to its attractive design

RoseBox

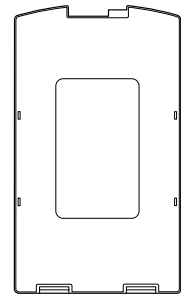

High-quality plastic cassettes in modern design. Ideal for all kinds of drill bit sets, precision tools, shank tools, special tool sets and spare parts

- modular concept – cassettes can be combined with individual foam inserts or vacuum formed inserts
- intergral secure locking mechanism to prevent unintended opening on impact
- adjustable and flexible length stop for tools
- modern design
- functional and user-friendly
- universal application
- resilient and stable
- excellent for stacking and storage
- space for labelling on cover and base
- optional with intergrated clear window in cover for optimum product presentation



PACKAGING
Packed assembled



- MATERIAL**
- Cover, base and length stop in ABS
 - Insert, closure and hanger in Polypropylene (PP)
 - Hinges in Polyamide (PA)



- COLORS**
- Bases in light gray
 - Cover, closure and hanger in dark gray
 - Insert and length stop in black
 - Additional colors and color combinations on request

DIMENSIONS



STANDARD COLORS



Product Range

Article	Holding devices	Suitable for	Index design	Standardization	Outer length	Outer width	Outer depth	PU
1A 87	30	Bits+Magnetic holder	30 Bits+Magnetic holder Ø 10mm		4.724in	3.425in	1.417in	90
2B 11	3	Sheet and tube drills	3-14/8-20/16-30.5		5.748in	3.937in	1.654in	54
3A 68	3	Sheet and tube drills	3-14/8-20/16-30.5+ cutting compound		6.772in	4.528in	1.654in	65
3A 33	15	Spiral point taps	each machine tap M3-M12+each 1 core hole drill 2.5/3.3/4.2/5/6.8/8.5/10.2+1 tapwrench	DIN 352	6.772in	4.528in	1.654in	65
2B 24	4	Deburring countersinks	2-5/5-10/10-15/15-20		5.748in	3.937in	1.654in	54
3A 60	5	Deburring countersinks	2-5/5-10/10-15/15-20/20-25		6.772in	4.528in	1.654in	65
2B 58	6	Flat counter-bores	M3/M4/M5/M6/M8/M10	DIN 373	5.748in	3.937in	1.654in	54
2B 85	5	Rotary burrs	Shank-diam. 6mm; 5 diff. head diameters, length 71mm		5.748in	3.937in	1.654in	54
2B 22	10	Rotary burrs	Shank-diam. 6mm; 10 diff. head diameters		5.748in	3.937in	1.654in	54
2B 90	10	Rotary burrs	Shank-diam. 6mm; 10 diff. head diameters, length 71mm		5.748in	3.937in	1.654in	54
1A 88	7	Threading dies	M3-M12		4.724in	3.425in	1.417in	90
4A 08	7	SDS drills	5.0x110/6.0x110/6.0x160/8.0x110/8.0x160/10.0x160/12.0x160 (SDS-Plus-Shaf)		7.874in	4.528in	1.654in	60
3A 20	21	Hand taps	1 set (3) each hand taps M3/M4/M5/M6/M8/M10/M12	DIN 352	6.772in	4.528in	1.654in	65
3A 43	21	Hand taps	1 set (3) each hand taps M3/M4/M5/M6/M8/M10/M12	ISO 529	6.772in	4.528in	1.654in	65
4B 107	21	Hand taps	1/8. 3/16. 1/4. 5/16. 3/8. 7/16. 1/2 BSW // 3/16-1/2 UNC. UNF. BSF	DIN 338	7.874in	4.528in	2.283in	38
4B 41	28	Hand taps	1 set (3) each hand taps M3-M12+ each 1 drill 2.5/3.3/4.2/5/6.8/8.5/10.2	DIN 352	7.874in	4.528in	2.283in	38
4B 54	28	Hand taps	1 set (3) each hand taps M3-M12+each 1 drill 2.5/3.3/4.2/5/6.8/8.5/10.2	DIN 335-C	7.874in	4.528in	2.283in	38
2B 106	11	HSS drills	1.0-6.0x0.5mm	DIN 338	5.748in	3.937in	1.654in	54
2B 103	13	HSS drills	1/16"-1/4"x1/64"	ANSI Jobber Length/ DIN 338	5.748in	3.937in	1.654in	54
3A 117	19	HSS drills	1.0-10.0x0.5mm	DIN 338	6.772in	4.528in	1.654in	65
3A 06	21	HSS drills	1/16"-3/8"x1/64"	DIN 338	6.772in	4.528in	1.654in	65
4A 05	15	HSS drills	1/16"-1/2"x1/32"	DIN 338	7.874in	4.528in	1.654in	60
4B 09	24	HSS drills	1.0-10.5x0.5mm+core hole drills 3.3/4.2/6.8/10.2	DIN 338	7.874in	4.528in	2.283in	38
4B 03	25	HSS drills	1.0-13.0x0.5mm	DIN 338	7.874in	4.528in	2.283in	38
4B 105	26	HSS drills	Letter Gauge Drills A-Z (Jobber Length) (ASME B94.11 M)		7.874in	4.528in	2.283in	38
4B 07	29	HSS drills	1/16"-1/2"x1/64"	DIN 338	7.874in	4.528in	2.283in	38
4B 95	29	HSS drills	1.0-13.0x0.5mm+core hole drills 3.3/4.2/6.8/10.2	ISO 529	7.874in	4.528in	2.283in	38
4B 36/8	50	HSS drills	1.0-5.9x0.1mm	ISO 338	7.874in	4.528in	2.283in	38
4B 36	51	HSS drills	1.0-6.0x0.1mm	DIN 338	7.874in	4.528in	2.283in	38
5B 72	41	HSS drills	6.0-10.0x0.1mm	DIN 338	7.874in	6.575in	2.559in	24
5B 104	60	HSS drills	Wire Gauge Drills 1-60 (ASME B94.11 M)		7.874in	6.575in	2.559in	24



The practical packaging solution offers maximum product protection for diverse applications

Product Range



PACKAGING
Packed assembled



MATERIAL

- Cover, base and length stop in ABS
- Insert, closure and hanger in Polypropylene (PP)
- Hinges in Polyamide (PA)



COLORS

- Bases in light gray
- Cover, closure and hanger in dark gray
- Insert and length stop in black
- Additional colors and color combinations on request

DIMENSIONS

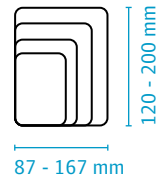

STANDARD COLORS



Article	Holding devices	Suitable for	Index design	Standardization	Outer length	Outer width	Outer depth	PU
3A 83	19	HSS short drills	1.0-10.0x0.5mm	DIN 1897	6.772in	4.528in	1.654in	65
2B 78	5	Countersinks	6.3/10.4/16.5/20.5/25	DIN 335-C	5.748in	3.937in	1.654in	54
2B 12	6	Countersinks	6.3/8.3/10.4/12.4/16.5/20.5	DIN 335-C	5.748in	3.937in	1.654in	54
2B 13	6	Countersinks	6/8/10/11.5/15/19	DIN 335-C	5.748in	3.937in	1.654in	54
2B 14	6	Countersinks	6.3/8.3/10.4/12.4/16.5/20.5 lang	DIN 335-C	5.748in	3.937in	1.654in	54
2B 69	7	Countersinks	6/8/10/11.5/15/19/25	DIN 335-C	5.748in	3.937in	1.654in	54
4A 88	6	Countersinks	6.3-20.5 with extra long shank	DIN 335-C	7.874in	4.528in	1.654in	60
4B 62	17	Countersinks	4.3/5/6/6.3/7/8/8.3/10/10.4/11.5/12.4/15/16.5/19/20.5/23/25	DIN 338	7.874in	4.528in	2.283in	38
3A 74	7	Countersinks-Bits	6 countersink bits 6.3/8.3/10.4/12.4/16.5/20.5 mm+-bit holder Ø 1/4". handle and cutting compound	DIN 3126 C 6.3	6.772in	4.528in	1.654in	65
1A 80	6	Combined tap and drills+magnetic holder	6 combined tap and drill bits (M3-M12)+magnetic holder Ø 10mm		4.724in	3.425in	1.417in	90
2B 35	7	Machine taps	M3-M12	DIN 371/376	5.748in	3.937in	1.654in	54
3A 10	14	Machine taps	each machine tap M3-M12+core hole drill 2.5/3.3/4.2/5/6.8/8.5/10.2	DIN 371/376	6.772in	4.528in	1.654in	65
3A 89	14	Machine taps	each machine tap M3-M12+core hole drill 2.5/3.3/4.2/5/6.8/8.5/10.2	ISO 529	6.772in	4.528in	1.654in	65
3A 76	10/12	Screwdriver	5 screwdrivers+5 drills for M3-M18 (1/8"-3/4") or 6 screwdrivers+6 drills M3-M24 (1/8"-1")		6.772in	4.528in	1.654in	65
2B 30	6	Countersink bits HSS	6.3/8.3/10.4/12.4/16.5/20.5+bit holder Ø 1/4"	DIN 3126 C 6.3	5.748in	3.937in	1.654in	54
2B 21	3	Step drills	4-12/12-20/20-30		5.748in	3.937in	1.654in	54
2B 23	3	Step drills	4-12/4-20/6-30		5.748in	3.937in	1.654in	54
3A 71	3	Step drills	4-12/12-20/20-30+cutting compound		6.772in	4.528in	1.654in	65
4A 37	6	Pin punches	2/3/4/5/6/8	DIN 6450 C	7.874in	4.528in	1.654in	60
4A 29	7	Masonry drills	4.0/5.0/6.0/6.0/8.0/10.0/12.0	DIN 8039	7.874in	4.528in	1.654in	60



Transport & Storage systems

Everything in perfect order

The bottom line is that your customers want products that are safe, clean, and well organized. And YOU want your customers to come back – not your products. Our sturdy and safe transport and organizing systems are the perfect way to create order from chaos – while optimally protecting your products.



AQRADO

Versatile drawer storage system for garage workshop, laboratory, office and home – modular, customized and installed in seconds!
more on page 158



StorePack

Smart packaging, sales promotion and storage system in one solution – perfectly organized and safely stored.
more on page 164

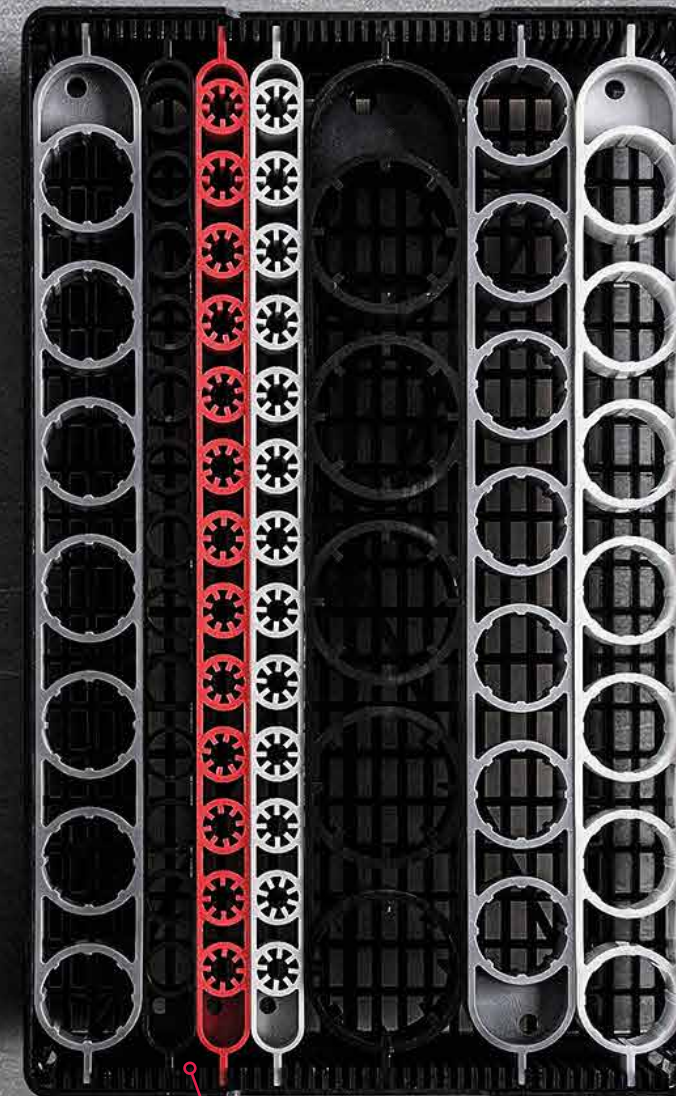

SystemBoard

Transport and storage container in modular design for organized storage and safe transportation of cutting tools
more on page 166



LogisticSystem

One box – countless possibilities! Packaging system for safe storage and transportation of tools during reconditioning
more on page 162

PLEASE
INQUIRE FOR
INDIVIDUAL DRAWER
SETS IN SMALL
QUANTITIES

AQRADO®

Versatile drawer storage system for garage workshop, laboratory, office and home – modular, customized and installed in seconds!

- wide product range to suit individual applications
- suitable for every drawer size
- neat arrangement means quick access and efficient working
- perfect protection of instruments and tools
- numerous modules for universal application as well as for special items such as calipers, socket sets, spanners, drills, laboratory equipment and stationery...
- base pad can be cut in all sizes in 24 mm increment spacings
- excellent for stacking and storage



PACKAGING

Parts are packed separately in individual cartons



MATERIAL

- Modules: Polystyrene (PS)
- Base pad: ABS



COLORS

- Standard color black and gray



ACCESSORIES

- Cutting guide/aid
- Multi-purpose knife
- Adhesive pads
- Label tab
- Eccentric fixing pins
- Assembly kit
- Cover
- Divider

OUTER DEPTHS



0.945 and 1.89in

OUTER DIMENSIONS

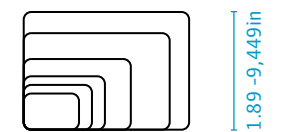

2,874 - 15,118in

STANDARD COLORS



Product Range

Aqurado Sets

Article	Description	Outer length	Outer width	Outer height	PU
AQ-Set 5443	12 modules + base pad	23.622in	16.063in	0.945in	1
AQ-Set 5444	11 modules + base pad	23.622in	22.677in	1.89in	1
AQ-Set 5445	20 modules + base pad	23.622in	23.622in	1.89in	1
AQ-Set 5446	24 modules + base pad	20.787in	18.898in	0.945in	1

Aqurado Modules

Article	Description	Outer length	width	height	PU
AQ-Multi 0102	3 compartments	7.559in	3.78in	0.945in	84
AQ-Multi 0103	2 compartments	11.339in	3.78in	0.945in	56
AQ-Multi 0113	8 compartments	7.559in	5.669in	0.945in	56
AQ-Spezial 2110	for 12 open-end/ring spanners	13.228in	9.449in	1.89in	9
AQ-Spezial 2111	for 8 double-ended ring wrench	13.228in	9.449in	1.89in	9
AQ-Spezial 2112	hex key 1.5/2/2.5/3/4/5/6/8/10	11.339in	3.78in	0.945in	20
AQ-Spezial 2113	for calipers	11.339in	3.78in	0.945in	20
AQ-Spezial 2114	for 6 screw drivers	15.118in	5.669in	1.89in	14
AQ-Spezial 2115	for twist drills (1.0-6.0 mm)	5.669in	5.669in	1.89in	12
AQ-Spezial 2116	for twist drills (6.1-10.0 mm)	7.559in	5.669in	1.89in	8
AQ-Spezial 2117	for multi-media, for 11 CDs	7.559in	5.669in	1.89in	8
AQ-Spezial 2118	for 10 collets (ER 16)	5.669in	3.78in	1.89in	16
AQ-Spezial 2119	for 16 collets (ER 25)	11.339in	3.78in	1.89in	8
AQ-Spezial 2120	for 12 collets (ER 32)	11.339in	3.78in	1.89in	8
AQ-Spezial 2121	for 12 collets (444 E)	11.339in	3.78in	1.89in	8
AQ-Spezial 2122	for 13 collets (ER 40)	13.228in	3.78in	1.89in	9
AQ-Spezial 2123	for socket sets (22 pcs.)	15.118in	5.669in	1.89in	14
AQ-Uni 0100		3.78in	1.89in	0.945in	120
AQ-Uni 0101		3.78in	3.78in	0.945in	60
AQ-Uni 0104		7.559in	3.78in	0.945in	84
AQ-Uni 0105		3.78in	3.78in	1.89in	84
AQ-Uni 0106		7.559in	3.78in	1.89in	72
AQ-Uni 0107		9.449in	3.78in	1.89in	57
AQ-Uni 0108		11.339in	3.78in	1.89in	48
AQ-Uni 0109		13.228in	3.78in	1.89in	39
AQ-Uni 0110		11.339in	3.78in	0.945in	56
AQ-Uni 0111		5.669in	3.78in	1.89in	56
AQ-Uni 0112		5.669in	3.78in	0.945in	40
AQ-Uni 0114		15.118in	5.669in	1.89in	24
AQ-Uni 0115		13.228in	9.449in	1.89in	15
AQ-Uni 0116		5.669in	5.669in	1.89in	64
AQ-Uni 0117		7.559in	5.669in	1.89in	48
AQ-Uni 0118	module for 5 dividers	5.669in	5.669in	1.89in	64
AQ-Uni 0119	module for 7 dividers	7.559in	5.669in	1.89in	48
AQ-Uni 0120	module for 15 dividers	15.118in	5.669in	1.89in	24
AQ-Uni 0121		7.559in	2.835in	1.89in	56
AQ-Uni 0122		7.559in	2.835in	0.945in	40
AQ-Vario 1114	end-piece, 8 compartments	7.559in	1.89in	0.945in	60
AQ-Vario 1115	end-piece, 8 compartments	7.559in	2.874in	0.945in	40
AQ-Vario 1116	end-piece, 3 compartments	3.78in	3.78in	0.945in	60
AQ-Vario 1117	end-piece, 2 compartments	3.78in	3.78in	0.945in	60
AQ-Vario 1118	end-piece, 1 compartments	2.874in	1.89in	0.945in	80
AQ-Vario 1119	end-piece, 1 compartments	3.78in	3.78in	0.945in	60
AQ-Vario 1121	end-piece, 1 compartments	3.622in	2.835in	1.89in	32
AQ-Vario 1122	end-piece, 1 compartments	3.622in	2.835in	0.945in	80

Vario modules: two parts needed

Compartmentalized thinking can sometimes make sense - if it ensures perfect organization

Product Range

Aqurado accessories

Article	Description	Outer length	Outer width	Outer height	PU
AQ-Extra 4100	cutting guide/aid				25
AQ-Extra 4101	multi-purpose knife				60
AQ-Extra 4102	adhesive pads (6 pcs.)				25
AQ-Extra 4103	adhesive pads (34 pcs.)				50
AQ-Extra 4104	label tab (vertical)	1.772in	0.512in		50
AQ-Extra 4105	label tab (horizontal)	1.89in	0.591in		50
AQ-Extra 4107	eccentric fixing pins				20
AQ-Extra 4390	assembly kit				10
AQ-Extra 4400	cover	3.78in	3.78in		10
AQ-Extra 4401	cover	3.78in	1.89in		10
AQ-Extra 4402	cover	5.669in	3.78in		10
AQ-Extra 4403	cover	7.559in	3.78in		10
AQ-Extra 4500	divider			2.362in	10
AQ-Extra 4501	divider			3.937in	10

Aqurado base pad

Article	Outer length	Outer width	PU
AQ-Base 3907	62.362in	24.567in	16



PACKAGING

Parts are packed separately in individual cartons



MATERIAL

- Modules: Polystyrene (PS)
- Base pad: ABS



COLORS

- Standard color
- black and gray



ACCESSORIES

- Cutting guide/aid
- Multi-purpose knife
- Adhesive pads
- Label tab
- Eccentric fixing pins
- Assembly kit
- Cover
- Divider

INNER DEPTHS

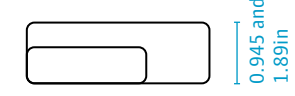

INNER DIMENSIONS

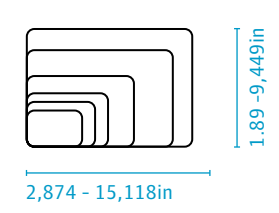

STANDARD COLORS



Logistic Box

Transport box with handle for heavy items

- Ergonomically shaped handle allows carrying the box close to the body, thus protecting the back.
- The detachable lid with snap lock makes it easier to safely pour out the contents.
- The Logistic Box can be stacked and palletized both empty and full.
- Individual customization through printing for clear organization.
- Flexible fitting with inserts or foams possible, allowing it to be individually adapted for different applications.



Product Range

Article	Outer dimensions H x W x D	PU
LB 185	7.28 x 8.26 x 5.90	20



PACKAGING

Carton



MATERIAL

- Polypropylene (PP)
- Recyclate rPP 63 (gray)



COLORS

- black
- gray

STANDARD COLORS



LogisticSystem

One box – countless possibilities! Packaging system for safe storage and transportation of tools during reconditioning

Boxes

- available in three sizes with padded lid
- boxes 175 and 235 can be combined with the rose plastic SystemBoard
- standardized, stable and stackable box system
- can be labeled and combined with an optional trolley

SystemBoard

- ideal for sorting, organizing and transporting of tools
- automatable, flexible system with various adjustable inserts
- suitable for immersion baths for cleaning and coating

Foam Trays

- flexible for use with different tool lengths and diameters
- made of high-strength material, with recessed grips
- adjustable separators for different tool lengths
- lower risk of injury due to lying transport of tools
- can be laser-engraved with a minimum quantity of 50 pieces



PACKAGING

Parts are packed separately in individual cartons



MATERIAL

- Box, lid and latches in Polypropylene (PP), scratch-resistant
- Trolley in ABS
- Stable, durable and water-resistant foam with high density



COLORS

- Boxes in light gray
- Trolley in red
- Foam in black
- Separators in red



ACCESSORIES

- Trolley
- Separators
- Foam Trays
- SystemBoard (see page 166)
- SystemBoard fixing set

OUTER DEPTHS

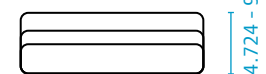

OUTER DIMENSION

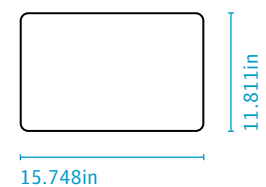

STANDARD COLORS



Product Range

LogisticSystem

Article	Description	Outer length	Outer width	Outer height	PU
F-RLSBX-SE 120 K	Box 120 incl. foam lid	15.748in	11.811in	4.724in	1
F-RLSBX-SE 175 K	Box 175 incl. foam lid	15.748in	11.811in	6.89in	1
F-RLSBX-SE 235 K	Box 235 incl. foam lid	15.748in	11.811in	9.252in	1
RLSW	Trolley	24.409in	16.535in	6.102in	1

LogisticSystem foam trays

Article	Description	Outer length	Outer width	Outer height	PU
SE RLS 10	Separators for foam trays	12.441in	0.669in	0.394in	10
SE RLS 32/14 14 A.	Foam tray with 14 slots	14.016in	10.039in	1.26in	1
SE RLS 32/20 10 A.	Foam tray with 10 slots	14.016in	10.039in	1.26in	1
SE RLS 40	SystemBoard fixing set	14.173in	2.362in	1.575in	1

Finally – a way to ensure everything is neatly squared away! Contains 100% pure organization

StorePack

Smart packaging, sales promotion and storage system in one solution – perfectly organized and safely stored

- modular packaging, sales and organization system
- sustainable packaging with the additional benefit of an organization system
- wide product range to suit individual applications
- suitable for every drawer size
- modules can be simply assembled onto the base pad with just one “click”
- selected modules are available with hangers and covers – ideal for the sale of products that are packed in modules at the Point of Sale
- combine with the RoseCassette to create a practical assortment box – keeps the contents safe and well organized during transportation
- stackable due to the special base contour

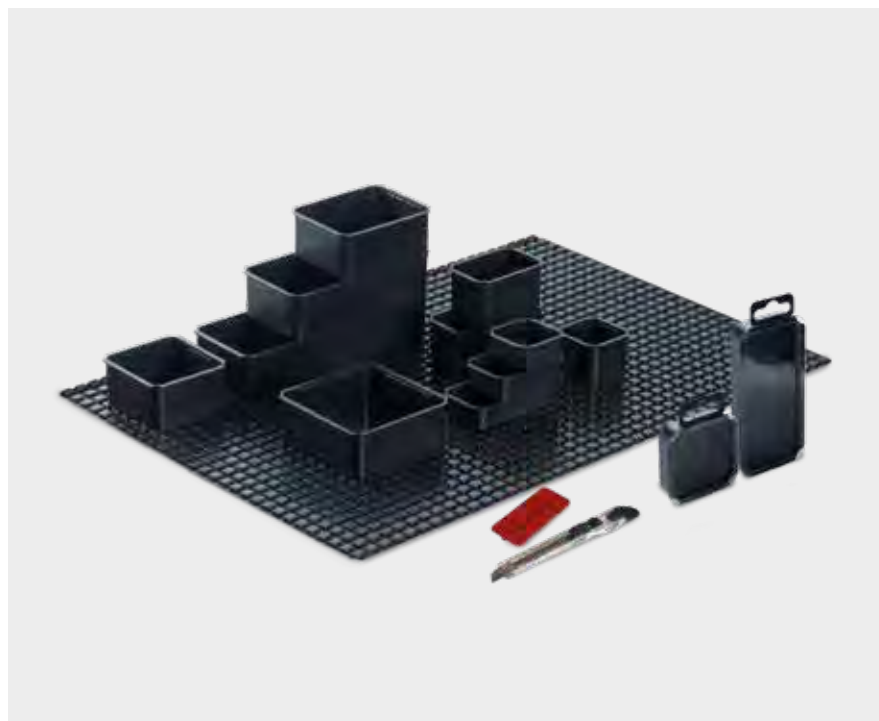

PACKAGING

Parts are packed separately in individual cartons



MATERIAL

- Module and base pad: ABS
- Transparent cover: PET



COLORS

- Standard color black and white



ACCESSORIES

- Multi-purpose knife
- Cutting guide/aid
- Assembly kit
- Adhesive pads
- RoseCassette (see page 134)

INNER DEPTHS

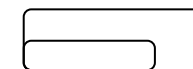

0,866 - 1,732in

INNER DIMENSION

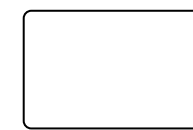

1,929 - 8,976in

STANDARD COLORS



Product Range

StorePack modules

Article	Description	Outer width	Outer height	Outer depth	Inner length	Inner width	Inner depth	PU
STPU-A 60x60x25/1 B	with hanger	3.071in	2.323in	1.024in	1.929in	1.929in	0.866in	420
STPU-A 90x60x25/1 B	with hanger	4.252in	2.323in	1.024in	3.11in	1.929in	0.866in	330
STPU-A 120x60x25/1 B	with hanger	5.433in	2.323in	1.024in	4.291in	1.929in	0.866in	240
STPU 60x60x25/1 B	without hanger	2.323in	2.323in	1.024in	1.929in	1.929in	0.866in	380
STPU 60x60x50/1 B	without hanger	2.323in	2.323in	1.929in	1.929in	1.89in	1.732in	180
STPU 90x60x25/1 B	without hanger	3.504in	2.323in	1.024in	3.11in	1.929in	0.866in	252
STPU 90x60x50/1 B	without hanger	3.504in	2.323in	1.929in	3.11in	1.89in	1.732in	120
STPU 90x90x50/1 B	without hanger	3.504in	3.504in	1.929in	3.11in	3.071in	1.732in	128
STPU 120x60x25/1 B	without hanger	4.685in	2.323in	1.024in	4.291in	1.929in	0.866in	300
STPU 120x60x50/1 B	without hanger	4.685in	2.323in	1.929in	4.291in	1.89in	1.732in	150
STPU 120x90x50/1 B	without hanger	4.685in	3.504in	1.929in	4.291in	3.071in	1.732in	100
STPU 120x120x50/1 B	without hanger	4.685in	4.685in	1.929in	4.291in	4.252in	1.732in	75
STPU 180x90x50/1 B	without hanger	7.047in	3.504in	1.929in	6.614in	3.071in	1.732in	64
STPU 240x90x50/1 B	without hanger	9.409in	3.504in	1.929in	8.976in	3.071in	1.732in	48

Using a cover reduces the usable inner height by approx. 4mm

StorePack cover

Article	Outer width	Outer height	Outer depth	PU
STPU 120x60/1 C	4.685in	2.323in	0.177in	2500
STPU 120x90/1 C	4.685in	3.504in	0.177in	3200
STPU 120x120/1 C	4.685in	4.685in	0.177in	3200

StorePack base pad

Article	Outer length	Outer width	PU
STPB 300x206/1	11.811in	8.11in	1
STPB-S 330x450/1	12.992in	17.717in	1
STPB-S 465x450/1	18.307in	17.717in	1
STPB-S 600x450/1	23.622in	17.717in	1
STPB 930x450/1	36.614in	17.717in	1

StorePack accessories

Article	Description	PU
D-STPE 4101	multi-purpose knife	1
STPE 4100	cutting guide/aid	1200
STPE 4390	assembly kit	50
AQ-Extra 4102	adhesive pads (6 pcs.)	25

Awards



Reusable system to prevent waste. The perfect way to create order instead of waste

SystemBoard

Transport and storage container in modular design for organized storage and safe transportation of cutting tools

- interchangeable inserts (diam. 3-40 mm) offer options for customizing
- precise positioning allows automatic loading and unloading
- usable depth 25 mm or 40 mm simply by reversal of inserts
- stackable, fits for stock and transport boxes
- sturdy design, combined with impact resistant material ensures protection against damage
- intermediate frame 400 B for long parts
- suitable for immersion baths for cleaning and coating
- temperature resistant (up to 120 degrees Celsius)
- solvent resistant



PACKAGING

Parts are packed separately in individual cartons



MATERIAL

- Polyamid (PA 6)



COLORS

- Frames and intermediate frames in black
- Inserts in various colors
- Pegboards in black



ACCESSORIES

- LogisticSystem (see page 162)

SHANK DIAM.

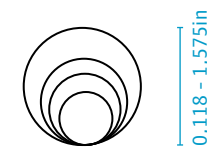

DIMENSION

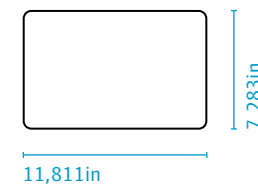

STANDARD COLORS



Product Range

SystemBoard frames

Article	Description	Outer length	Outer width	Outer height	PU
SystemBoard 400A	frame with bottom	11.811in	7.283in	2.244in	25
SystemBoard 400B	intermediate frame w/o bottom	11.811in	7.283in	2.244in	25

SystemBoard inserts

Article	Shank diam.	Shank diam. (in.)	No. of holding devices	Height of inserts	max. number of inserts/frames	PU
Systemboard 401-3 GF	0,118in		13	0,984in	12	100
Systemboard 401-1/8" GF	0,125in	1/8	13	0,984in	12	100
Systemboard 401-4 GF	0,157in		13	0,984in	12	100
Systemboard 401-5 GF	0,197in		13	0,984in	12	100
Systemboard 401-6 GF	0,236in		13	0,984in	12	100
Systemboard 401-1/4" GF	0,250in	1/4	13	0,984in	12	100
Systemboard 401-7 GF	0,276in		13	0,984in	12	100
Systemboard 401-8 GF	0,315in		13	0,984in	12	100
Systemboard 401-9 GF	0,354in		13	0,984in	12	100
Systemboard 401-3/8" GF	0,375in	3/8	13	0,984in	12	100
Systemboard 401-10 GF	0,394in		13	0,984in	12	100
Systemboard 401-11 GF	0,433in		13	0,984in	12	100
Systemboard 401-12 GF	0,472in		13	0,984in	12	100
Systemboard 405-12 GF	0,472in		7	0,984in	6	50
Systemboard 405-1/2" GF	0,500in	1/2	7	0,984in	6	50
Systemboard 405-13 GF	0,512in		7	0,984in	6	50
Systemboard 405-14 GF	0,551in		7	0,984in	6	50
Systemboard 405-15 GF	0,591in		7	0,984in	6	50
Systemboard 405-16 GF	0,630in		7	0,984in	6	50
Systemboard 405-17 GF	0,669in		7	0,984in	6	50
Systemboard 405-18 GF	0,709in		7	0,984in	6	50
Systemboard 405-19 GF	0,748in		7	0,984in	6	50
Systemboard 405-3/4" GF	0,750in	3/4	7	0,984in	6	50
Systemboard 405-20 GF	0,787in		7	0,984in	6	50
Systemboard 405-21 GF	0,827in		7	0,984in	6	50
Systemboard 405-22 GF	0,866in		7	0,984in	6	50
Systemboard 405-23 GF	0,906in		7	0,984in	6	50
Systemboard 405-24 GF	0,945in		7	0,984in	6	50
Systemboard 405-25 GF	0,984in		7	0,984in	6	50
Systemboard 405-1" GF	1,000in	1	7	0,984in	6	50
Systemboard 405-26 GF	1,024in		7	0,984in	6	50
Systemboard 407-28 GF	1,102in		5	0,984in	4	25
Systemboard 407-30 GF	1,181in		5	0,984in	4	25
Systemboard 407-32 GF	1,260in		5	0,984in	4	25
Systemboard 407-34 GF	1,339in		5	0,984in	4	25
Systemboard 407-36 GF	1,417in		5	0,984in	4	25
Systemboard 407-38 GF	1,496in		5	0,984in	4	25
Systemboard 407-40 GF	1,575in		5	0,984in	4	25
Systemboard 412 GF	0,669x0,669in		28	0,315in	4	100

SystemBoard pegboards

Article	Length	PU
SystemBoard Pegboards 422	7.008in	300
SystemBoard Pegboards 437	11.693in	250



Tidiness is mandatory.
This makes it even easier
to get/stay organized

SZS-Stands

Plastic storage tray for ER collets

- for 14, 16, 18 or 20 ER collets
- sturdy, safe, oil-resistant
- economical alternative to wooden stands



Product Range

Article	Suitable for	Number of holding devices	Outer length	Outer width	Outer height	PU
SZSER 8/16	ER 8	16	8.661in	2.362in	0.984in	70
SZSER 11/16	ER 11	16	8.661in	2.362in	0.984in	70
SZSER 16/16	ER 16	16	8.661in	2.362in	0.984in	70
SZSER 20/16	ER 20	16	8.661in	2.362in	0.984in	70
SZSER 25/20	ER 25	20	8.661in	6.063in	1.102in	55
SZSER 32/18	ER 32	18	13.583in	3.937in	1.181in	48
SZSER 32/20	ER 32	20	8.661in	6.063in	1.102in	50
SZSER 40/14	ER 40	14	13.583in	3.937in	1.181in	48



PACKAGING
Carton



MATERIAL
- Polystyrene (PS)



COLOR
- Standard color black

STANDARD COLOR



Hangers & Accessories

What else do you need?

From hangers, end caps, and foam inserts to protective caps and Eurohole hangers – our accessories make our versatile plastic packaging even more effective.

Protective EndCaps PSC

Protective caps for polygonal taper shank tool holders according to ISO 26623-1 *more on page 178*



ToolHolder

Safer transport of tool holding fixtures *more on page 186*

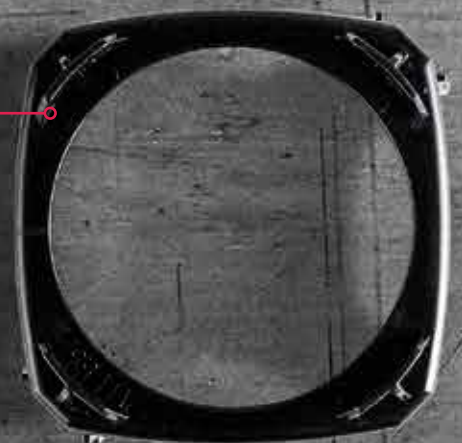

SDS-Clip

Plastic euro hangers for in-store display of masonry drills, chisels and drill bits *more on page 185*



DIY-Perforated Disc

Plastic euro hanger with perforated disc *more on page 174*



Foam Inserts

Foam inserts for rose plastic tubes and boxes *more on page 180*





BlockPack Hanger

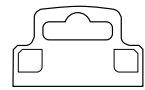

Separate hanger caps for the BlockPack packaging tubes

- separate hanger caps can be clipped on the bottom of the BlockPack outer and inner part
- for filling weights up to 2,5 kg (fixing at the outer part, static load)
- hanger available for BK 14, 20, 26, 32, 35, 45 and 55



Product Range

Article	Suitable for	max. filling weight	PU
BK 14/1	BK 14 in PE/PP	1kg	500
BK 14/2	BK 14 in PVC	1kg	500
BK 20/1	BK 20 in PE/PP	1kg	500
BK 20/2	BK 20 in PVC	1kg	500
BK 22/1	BK 22 in PE/PP	1kg	500
BK 22/2	BK 22 in PVC	1kg	500
BK 26/1	BK 26 in PE/PP	2kg	500
BK 26/2	BK 26 in PVC	2kg	500
BK 32/1	BK 32 in PE/PP	2kg	500
BK 32/2	BK 32 in PVC	2kg	500
BK 35/1	BK 35 in PE/PP	2.5kg	500
BK 35/2	BK 35 in PVC	2.5kg	500
BK 45/1	BK 45 in PE/PP	2.5kg	500
BK 55/1	BK 55 in PE/PP	2.5kg	500
BK 55/2	BK 55 in PVC	2.5kg	500



PACKAGING
Carton



MATERIAL

- Polyethylene (PE)
- Polypropylene (PP)
- Recycled plastic



COLORS

- Depending on the material transparent, natural or in various attractive standard colors



ACCESSORIES

- BlockPack (see page 14)

STANDARD COLORS



BlockPack EndCaps

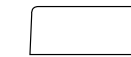

End caps for additional protection of sharp objects

- prevents the content from penetrating
- made from impact resistant ABS
- end caps can be clipped on the bottom of the BlockPack outer and inner part
- end caps available for BK 32, 45, 65 and 85
- only suitable for BlockPack in PVC



Product Range

Article	Suitable for	PU
BKEC-P 32/2	BK 32 in PVC	1000
BKEC-P 45/2	BK 45 in PVC	500
BKEC-P 65/2	BK 65 in PVC	250
BKEC-P 85/2	BK 85 in PVC	140



PACKAGING
Carton



MATERIAL

- Impact resistant ABS plastics



COLORS

- ABS black or in various attractive standard colors



ACCESSORIES

- BlockPack (see page 14)

STANDARD COLORS





DIY-Clips

DIY-Clips – for a firm grip, simple assembly, and perfect product presentation at the point of sale

- DIY-Adapter – plastic euro hanger for in-store display of products with simple round hole on euro hooks
- DIY-Clip for Flat Bits – plastic euro hanger with cable tie
- DIY-Clip for Sockets, Core Drills and Hole Saws – plastic euro hanger with square plug with ribbed surface
- DIY-Clip with Cable Tie – plastic euro hanger with cable tie
- DIY-Perforated Disc – plastic euro hanger with perforated disc with variable perforation for securing product with cable tie
- DIY-UniClip – plastic euro hanger with cable tie and fixing disk
- DIY-PouchClip – plastic euro hanger with hinged lid closure for plastic bags

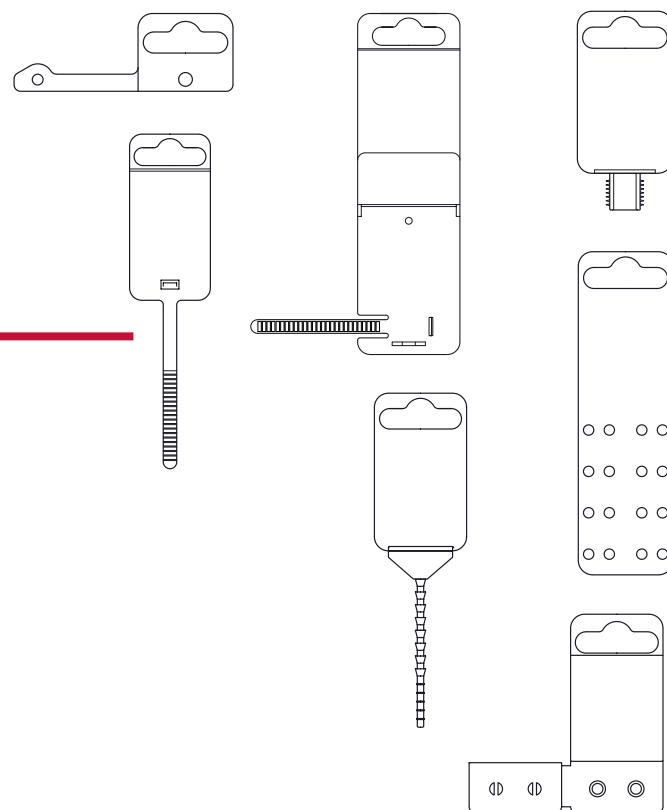

PACKAGING

Carton



MATERIAL

– Polypropylene (PP)



COLORS

– Available in various attractive standard colors – please inquire

STANDARD COLORS



These small, practical helpers are reliable product protectors and accomplished salesmen in one

Product Range

1 DIY-Adapter

Article	Hanger length	Hanger width	PU
DYC 36x30/1	1.181in	1.417in	

2 DIY-Clip for Flat Bits

Article	Hanger width	Hanger length	Length of cable tie	PU
DYC 45x150 /1	1.772in	5.906in	2.362in	600

3 DIY-Clip for Sockets, Core Drills and Hole Saws

Article	Suitable for	Hanger length	Hanger width	Tool holder diam.	PU
DYC 36x61 6.3/2	socket	2.402in	1.417in	0.248in	3500
DYC 36x61 9.5/2	socket	2.402in	1.417in	0.374in	2000
DYC 36x61 12.7/2	socket/core drill M16/hole saw from Ø 32mm	2.402in	1.417in	0.5in	2000
DYC 36x68 14/2	hole saw up to Ø 30mm	2.677in	1.417in	0.551in	3000

4 DIY-Clip with Cable Tie

Article	Hanger width	Hanger length	Length of cable tie	PU
DYC 36x74 075/1	2.913in	1.417in	2.953in	4000
DYC 36x74 115/1	2.913in	1.417in	4.528in	2500
DYC 36x74 150/1	2.913in	1.417in	5.906in	2000

5 DIY-Perforated Disc

Article	Hanger length	Hanger width	PU
DYL 36x123/1	4.843in	1.417in	500
DYL 60x140/1	5.512in	2.362in	350

6 DIY-UniClip

Article	Description	Hanger length	Hanger width	Length of cable tie	PU
DYC 36x74 075/2		2.913in	1.417in	2.953in	800
DYC 36x74 150/2		2.913in	1.417in	5.906in	800
DYC 26x12/2	fixing disc	0.472in	1.024in		5000

7 DIY-PouchClip

Article	Hanger length	Hanger width	PU
DYC 36x77/1	3.031in	1.417in	2000



ProtectiveCap



Flexible, light and suitable protection for multiple tool diameters

- suitable for tools from Ø 3 mm up to Ø 30 mm
- the single sizes are suitable for multiple tool diameters
- flexible material for easy assembly and removal
- compatible with our TopPack products



PACKAGING

Available from 1 packaging unit (in bag or carton depending on size)



MATERIAL

- TPE with 40% recycled material / EVA



COLOR

- PCAP Size 01-12: gray
- PCAP Size 13-17: natural

SHANK DIAM.

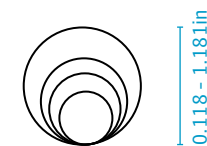

STANDARD COLOR



Product Range

Article	Suitable for tool diam.	Suitable for no. of edges	Compatible with TopPack	PU (pcs./bag)	PU (pcs./carton)
PCAP Size 01/2	0.118in	2 / 3 / 4	TPK 8	1000	20000
	0.137in	2 / 4	TPK 8	1000	20000
	0.157in	2	TPK 8	1000	20000
PCAP Size 02/2	0.157in	3 / 4	TPK 8 / TPK 13	1000	20000
	0.177in	2 / 4	TPK 8 / TPK 13	1000	20000
	0.196in	2 / 3 / 4 / 6	TPK 8 / TPK 13	1000	20000
	0.216in	3 / 4 / 6	TPK 8 / TPK 13	1000	20000
PCAP Size 03/2	0.236in	2 / 4	TPK 8 / TPK 13	1000	20000
	0.255in	2 / 3 / 4 / 6	TPK 8 / TPK 13	1000	20000
	0.255in	2/4	TPK 8 / TPK 13	1000	16000
PCAP Size 04/2	0.275in	2 / 3 / 4	TPK 8 / TPK 13	1000	16000
	0.295in	4	TPK 8 / TPK 13	1000	16000
PCAP Size 05/2	0.314in	2 / 3 / 4 / 6	TPK 8 / TPK 13	1000	16000
	0.334in	4	TPK 13	1000	16000
	0.354in	2 / 3 / 4	TPK 13	1000	16000
PCAP Size 06/2	0.374in	4	TPK 13	1000	16000
	0.393in	2 / 3 / 4 / 6	TPK 13	1000	10000
	0.433in	4	TPK 13	1000	10000
PCAP Size 07/2	0.433in	4	TPK 13	1000	10000
	0.453in	4	TPK 13	1000	10000
	0.472in	2 / 3 / 4 / 5 / 6	TPK 13	1000	10000
PCAP Size 7.5/2	0.551in	4	TPK 18	1000	10000
	0.551in	2 / 3 / 4	TPK 18	1000	6000
PCAP Size 08/2	0.590in	4	TPK 18	1000	5000
	0.629in	2 / 3 / 4 / 6	TPK 18	1000	5000
	0.669in	2	TPK 18	1000	5000
PCAP Size 10/2	0.708in	2 / 3 / 4	TPK 20	500	3000
	0.748in	2	TPK 20	500	3000
PCAP Size 11/2	0.787in	2 / 3	TPK 20	500	3000
	0.787in	4 / 6	TPK 20	500	2500
PCAP Size 12/2	0.866in				1000
PCAP Size 13	0.944in				1000
PCAP Size 14	1.023in				750
PCAP Size 15	1.102in				600
PCAP Size 16	1.181in				500



Looking for reliable protection for tools and their users? Then simply put on the ProtectiveCap!



Protective EndCaps PSC

Protective caps for polygonal taper shank tool holders according to ISO 26623-1

- delicate polygonal taper shank tool holders are protected against dirt and damage during transportation and storage
- incorporated latches prevent unintentional release from the shank
- impact and crack resistant Polyethylene
- speedy handling
- durable and reusable
- sturdy, oil, and moisture resistant



Product Range

Article	Inner diam.	PU
PEPSC 32	1.26in	1250
PEPSC 40	1.575in	1300
PEPSC 50	1.969in	800
PEPSC 63	2.48in	350
PEPSC 80	3.15in	350



PACKAGING
Carton



MATERIAL
- Polyethylene (PE)



COLORS
- PE gray or in various attractive standard colors

INNER DIAM.



STANDARD COLORS



ERNST RÖSLER
Founder

Foam Inserts

Foam inserts for rose plastic tubes and boxes

- to provide additional protection for products susceptible to damage by impact e.g. carbide tooling, heavy milling cutters, delicate mechanical parts, etc.
- round foam inserts to accommodate diverse packaging tubes (QuadroPack, TwistPack, ScrewPack, TelePack etc.)
- square foam inserts to accommodate UniBox, UniCase etc.



PACKAGING
Completely packed in a carton



MATERIAL
- Foam



COLORS
- Square: white
- Round: white

DIAMETER

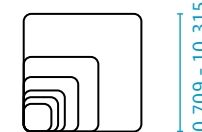

STANDARD COLOR



only shipped with other items due to low cost

Product Range

Square

Article	Outer length	Outer width	Outer height	PU
SE QU 18x5	0.709in	0.709in	0.197in	100
SE QU 25x4	0.984in	0.984in	0.157in	100
SE QU 25x7	0.984in	0.984in	0.276in	100
SE QU 48x7	1.89in	1.89in	0.276in	100
SE QU 35x4	1.378in	1.378in	0.157in	100
SE QU 38x14	1.496in	1.496in	0.551in	100
SE QU 38x11	1.496in	1.496in	0.433in	100
SE QU 38x6	1.496in	1.496in	0.236in	100
SE QU 50x18	1.969in	1.969in	0.709in	100
SE QU 50x9	1.969in	1.969in	0.354in	100
SE QU 63x7	2.48in	2.48in	0.276in	100
SE QU 68x7	2.677in	2.677in	0.276in	100
SE QU 72x25	2.835in	2.835in	0.984in	100
SE QU 72x13	2.835in	2.835in	0.512in	100
SE QU 90x7	3.543in	3.543in	0.276in	100
SE QU 90x12	3.543in	3.543in	0.472in	100
SE QU 103x12	4.055in	4.055in	0.472in	100
SE QU 103x7	4.055in	4.055in	0.276in	100
SE QU 105x15*	4.134in	4.134in	0.591in	100
SE QU 131x7	5.157in	5.157in	0.276in	100
SE QU 131x12	5.157in	5.157in	0.472in	100
SE QU 165x6	6.496in	6.496in	0.236in	100
SE QU 165x12	6.496in	6.496in	0.472in	100
SE QU 165x20	6.496in	6.496in	0.787in	100
SE QU 180x7*	7.087in	7.087in	0.276in	100
SE QU 180x15*	7.087in	7.087in	0.591in	100
SE QU 204x7	8.032in	8.032in	0.276in	100
SE QU 204x12	8.032in	8.032in	0.472in	100
SE QU 262x12	10.315in	10.315in	0.472in	100
SE QU 262x7	10.315in	10.315in	0.276in	100

*color black

Round

Article	Diameter	Outer height	PU	Article	Diameter	Outer height	PU
SE RU 8x9	0.315in	0.354in	100	SE RU 50x9	1.969in	0.354in	100
SE RU 10x9	0.394in	0.354in	100	SE RU 55x9	2.165in	0.354in	100
SE RU 12x9	0.472in	0.354in	100	SE RU 60x9	2.362in	0.354in	100
SE RU 14x9	0.551in	0.354in	100	SE RU 190x9	2.756in	0.354in	100
SE RU 16x9	0.63in	0.354in	100	SE RU 77x9	3.031in	0.354in	100
SE RU 20x9	0.787in	0.354in	100	SE RU 88x9	3.465in	0.354in	100
SE RU 22x9	0.866in	0.354in	100	SE RU 88x25	3.465in	0.984in	100
SE RU 25x9	0.984in	0.354in	100	SE RU 100x9	3.937in	0.354in	100
SE RU 26x9	1.024in	0.354in	100	SE RU 110x9	4.331in	0.354in	100
SE RU 28x9	1.102in	0.354in	100	SE RU 110x25	4.331in	0.984in	100
SE RU 30x9	1.181in	0.354in	100	SE RU 118x9	4.646in	0.354in	100
SE RU 35x9	1.378in	0.354in	100	SE RU 133x9	5.236in	0.354in	100
SE RU 40x9	1.575in	0.354in	100	SE RU 160x9	6.299in	0.354in	100
SE RU 45x9	1.772in	0.354in	100	SE RU 190x9	7.48in	0.354in	100



Wrapping tools in cotton wool has the same effect – but is much more expensive!

Foam Inserts for SplitPack and FivePack

Foam inserts for rose plastic SplitPack and FivePack

- foam chains for SplitPack and FivePack with 10 resp. 5 foam units
- for additional protection of sensitive cutting edges susceptible to damage by impact
- perfect embedding of the tool when using 2 foams at the front and back
- can be positioned freely in the units, so that even shorter tools can be fixed in the packaging
- much faster to insert than individual foams
- easily separable due to thin connecting strips
- the foam chains for FivePack and SplitPack have to be halved, because these packages have only 5 units



PACKAGING

Completely packed in a carton



MATERIAL

- Foam



COLORS

- silvergray

STANDARD COLOR



Product Range

Article	Outer length	Outer width	Outer height	Number of units	Suitable for	PU
SE RE 76x4x4/9 A.	2.992in	0.157in	0.157in	10	SplitPack 4	1
SE RE 106x7x6/9 A.	4.173in	0.276in	0.236in	10	SplitPack 6 / FivePack 6	1
SE RE 106x7x8/9 A.	4.173in	0.276in	0.315in	10	SplitPack 6 / FivePack 6	1
SE RE 106x7x10/9 A.	4.173in	0.276in	0.394in	10	SplitPack 6 / FivePack 6	1
SE RE 106x7x14/9 A.	4.173in	0.276in	0.551in	10	SplitPack 6 / FivePack 6	1
SE RE 129x9x6/9 A.	5.079in	0.354in	0.236in	10	SplitPack 8	1
SE RE 129x9x8/9 A.	5.079in	0.354in	0.315in	10	SplitPack 8	1
SE RE 129x9x10/9 A.	5.079in	0.354in	0.394in	10	SplitPack 8	1
SE RE 158x11x6/9 A.	6.22in	0.433in	0.236in	10	SplitPack 10 / FivePack 10	1
SE RE 158x11x8/9 A.	6.22in	0.433in	0.315in	10	SplitPack 10 / FivePack 10	1
SE RE 158x11x10/9 A.	6.22in	0.433in	0.394in	10	SplitPack 10 / FivePack 10	1
SE RE 94x14x6/4 A.	3.701in	0.551in	0.236in	5	SplitPack 12 / FivePack 12	1
SE RE 94x14x8/4 A.	3.701in	0.551in	0.315in	5	SplitPack 12 / FivePack 12	1
SE RE 94x14x10/4 A.	3.701in	0.551in	0.394in	5	SplitPack 12 / FivePack 12	1
SE RE 117x18x6/4 A.	4.606in	0.709in	0.236in	5	SplitPack 16	1
SE RE 117x18x8/4 A.	4.606in	0.709in	0.315in	5	SplitPack 16	1
SE RE 117x18x10/4 A.	4.606in	0.709in	0.394in	5	SplitPack 16	1

delivery together with rose plastic SplitPack or FivePack only



Gently placed in between soft foam inserts, so heavy impacts are safely cushioned

Protective Sleeves



Ideal for protection of cutting tips and edges

- additional protection for delicate tool cutting edges
- extensive range of sizes
- quick and easy loading of tools

Product Range

Article	Inner diam.	Outer length	Usable length fixed	PU (pcs./bag)	PU (pcs./carton)
Protective Sleeves Ø 3x20	0.118in	0.772in	0.472in	1000	20000
Protective Sleeves Ø 3.175x20	0.125in	0.772in	0.472in	1000	20000
Protective Sleeves Ø 3x45	0.118in	1.78in	1.378in	1000	10000
Protective Sleeves Ø 4x30	0.157in	1.161in	0.787in	1000	15000
Protective Sleeves Ø 4x45	0.157in	1.78in	1.378in	1000	10000
Protective Sleeves Ø 6x30	0.236in	1.161in	0.787in	1000	15000
Protective Sleeves Ø 6x45	0.236in	1.78in	1.378in	1000	10000

only shipped with other items due to low cost



PACKAGING
Available from 1 packaging unit (in bag)



MATERIAL
- Polypropylene (PP)



COLOR
- PP transparent

STANDARD COLOR



SDS-Clip

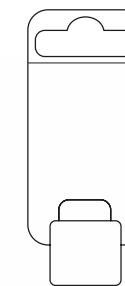

Plastic euro hangers for in-store display of masonry drills, chisels and drill bits

- clever patented system of display hanging clips
- attractive sales presentation
- one label suits all sizes of clip (32 x 45 mm)
- easy, efficient handling



Product Range

Article	Description	Hanger length	Hanger width	Tool holder diam.	PU
DYC 36x74 10/1	SDS-plus	2.913in	1.417in	0.394in	1250
DYC 36x90 10/1	SDS-plus II	3.606in	1.496in	0.394in	1000
DYC 36x74 14/1	SDS-top	2.913in	1.417in	0.551in	1500
DYC 36x74 18/1	SDS-max	2.913in	1.417in	0.709in	1500
DYC 40x110 18/1	SDS-max II	4.331in	1.575in	0.709in	1000



PACKAGING
Carton



MATERIAL
- SDS-plus, SDS-top, SDS-max: Polyethylene (PE)
- SDS-plus II, SDS-max II: Polypropylene (PP)
- SDS-plus II, SDS-max II: Polypropylene (PP) made from 100% recycled plastic (post-consumer recycle)



COLORS
- available in various attractive standard colors – please inquire
- SDS-plus II and SDS-max II also available made from 100% recycled plastic (post-consumer recycle)

STANDARD COLORS



ToolHolder

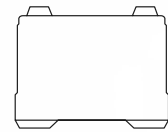

Safer transport of tool holding fixtures!

- ToolHolder in combination with BlockPack provides perfect packaging safety
- tight fit of the tool holders in axial and radial direction
- quick loading, efficient packing, simple removal
- the combination of ToolHolder insert and BlockPack tube reduces the packaging variety and saves warehouse resources
- high quality and sturdy individual packaging
- highly secure closure, but with minimal force in opening and closing the pack
- excellent for stacking and storage
- durable and reusable
- sturdy, oil, and moisture resistant



PACKAGING

ToolHolder as well as BlockPack outer parts and inner parts (not included in ToolHolder delivery) are packed separately in individual cartons



MATERIAL

- Polyethylene (PE)



COLOR

- ToolHolder insert in black



ACCESSORIES

- BlockPack (see page 14)

TOOL LENGTHS

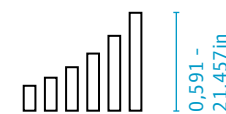

STANDARD COLOR



Product Range

Article	Suitable for	Suitable BlockPack inner part	Suitable BlockPack outer part	for tool length (in)	PU
BK TH 35/1	PSC 32/KM 32/HSK 32	BK 35 050 I BK 35 050 I BK 35 080 I BK 35 080 I BK 35 120 I BK 35 080 I	BK 35 050 A BK 35 080 A BK 35 080 A BK 35 120 A BK 35 120 A BK 35 200 A	0.98 - 1.81 2.05 - 2.95 2.05 - 3.74 3.74 - 5.31 3.74 - 6.89 6.89 - 8.46	300
BK TH 45/1	PSC 40/KM 40/HSK 40	BK 45 060 I BK 45 060 I BK 45 080 I BK 45 080 I BK 45 120 I BK 45 120 I	BK 45 060 A BK 45 080 A BK 45 080 A BK 45 120 A BK 45 120 A BK 45 200 A	0.98 - 1.77 1.77 - 2.56 1.77 - 3.35 3.35 - 4.92 3.35 - 6.50 6.50 - 9.65	300
BK TH 55/1	PSC 50/KM 50/HSK 50	BK 55 060 I BK 55 060 I BK 55 080 I BK 55 080 I BK 55 120 I BK 55 120 I BK 55 120 I BK 55 120 I BK 55 200 I BK 55 200 I BK 55 200 I BK 55 200 I	BK 55 060 A BK 55 080 A BK 55 080 A BK 55 120 A BK 55 120 A BK 55 200 A BK 55 200 A BK 55 200 A BK 55 350 A BK 55 350 A	0.59 - 1.57 1.57 - 2.36 1.57 - 3.15 3.15 - 4.72 3.15 - 6.30 6.30 - 9.45 0.94 - 1.73 0.94 - 2.52 2.52 - 4.09 2.52 - 5.67 5.67 - 8.82 5.67 - 11.57 11.57 - 17.48 11.57 - 22.20	300
BK TH 55/2	SK 30	BK 55 060 I BK 55 080 I BK 55 080 I BK 55 120 I BK 55 120 I BK 55 200 I BK 55 200 I BK 55 350 I	BK 55 080 A BK 55 080 A BK 55 120 A BK 55 120 A BK 55 200 A BK 55 200 A BK 55 350 A	0.94 - 1.73 0.94 - 2.52 2.52 - 4.09 2.52 - 5.67 5.67 - 8.82 5.67 - 11.57 11.57 - 17.48	
BK TH 65/1	PSC 63/KM 63/HSK 63	BK 65 080 I BK 65 080 I BK 65 120 I BK 65 120 I BK 65 120 I BK 65 200 I BK 65 200 I BK 65 200 I BK 65 350 I	BK 65 080 A BK 65 120 A BK 65 120 A BK 65 200 A BK 65 200 A BK 65 350 A BK 65 350 A	0.98 - 2.56 2.56 - 4.13 2.56 - 5.71 5.71 - 8.86 5.71 - 11.61 11.61 - 17.52 17.52 - 21.46	180
BK TH 65/2	SK 40	BK 65 080 I BK 65 120 I BK 65 120 I BK 65 200 I BK 65 200 I BK 65 200 I BK 65 350 I	BK 65 120 A BK 65 120 A BK 65 200 A BK 65 200 A BK 65 350 A BK 65 350 A	0.59 - 2.17 2.17 - 3.74 2.17 - 5.31 5.31 - 8.46 5.31 - 11.22 11.22 - 17.13	150
BK TH 85/1	PSC 80/KM 80/HSK 80	BK 85 080 I BK 85 080 I BK 85 120 I BK 85 120 I BK 85 200 I BK 85 200 I	BK 85 080 A BK 85 120 A BK 85 120 A BK 85 200 A BK 85 200 A	1.77 - 4.92 4.92 - 8.07 4.92 - 10.83 10.83 - 16.73 1.57 - 3.15 1.57 - 4.72	80
BK TH 105/1	PSC 100/KM 100/HSK 100	BK 105 120 I BK 105 120 I BK 105 200 I BK 105 200 I	BK 105 120 A BK 105 200 A BK 105 200 A BK 105 350 A	4.72 - 7.87 4.72 - 10.63 10.63 - 16.54 16.54 - 20.47	100
BK TH 105/2	SK 50	BK 105 120 I BK 105 200 I BK 105 200 I	BK 105 200 A BK 105 200 A BK 105 350 A	3.27 - 6.42 3.27 - 9.17 9.17 - 15.08	75



Wondering how to transport tool holders safely from A to B? Here is the solution ...

TopPack FiveFrame

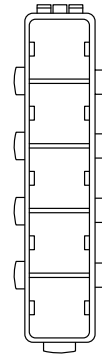

Plastic frame for bundling 5 TopPack packaging tubes

- to combine TopPack 8 or TopPack 13 packaging tubes in units of 5
- the TopPack base plugs snap securely into the FiveFrame and can be released from the frame with a simple push through
- the frames can be connected to each other as using a plug-in function
- several FiveFrames assembled together can be used as assembly aids or in the assembly process for holding stock
- possibility of prefabrication with TopPack base plugs
- easy handling, automated loading
- made of impact-resistant ABS
- reusable, as it can be used several times
- suitable for 5 base plugs from the TopPack family in sizes 8x18 or 13x25



PACKAGING

Carton



MATERIAL

- impact resistant ABS plastic



COLOR

- ABS black or in various attractive standard colors



ACCESSORIES

- TopPack (see page 62)
- TopPack FoldBack (see page 68)
- TopPack XPress (see page 74)

STANDARD COLOR



Product Range

Article	Suitable for	Outer length	Outer width	Outer height	PU
TKFF 8/1	5x TopPack 8x18	3.031in	0.787in	0.433in	1000
TKFF 13/1	5x TopPack 13x25	4.134in	0.984in	0.512in	700

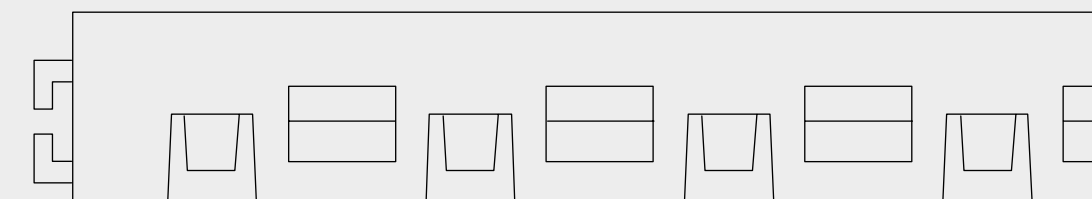
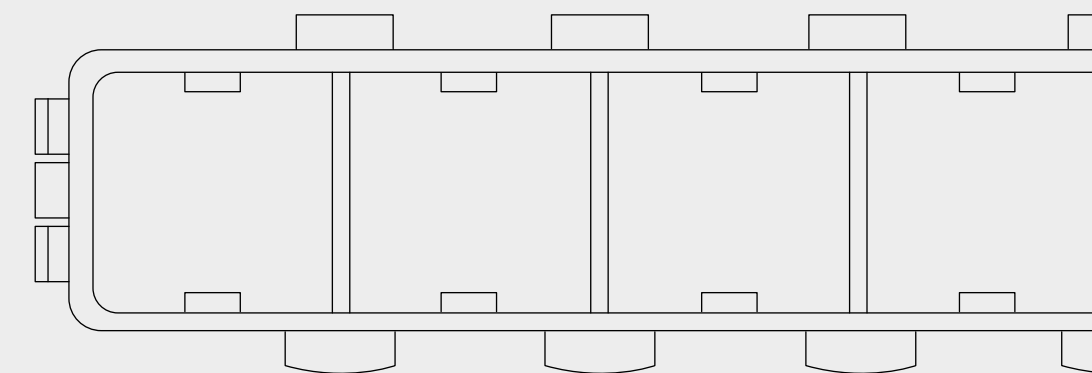

Everything stays in the frame: the sturdy, reusable frame secures five TopPack tubes each



HEADQUARTERS
Germany

Production locations

GERMANY

rose plastic AG

Rupolzer Straße 53
88138 Hergensweiler/Lindau
Tel. +49 8388 9200-0
info@rose-plastic.de

USA

rose plastic USA, L.L.L.P.

P.O. Box 698
California, PA 15419-0698
Tel. +1 724 938 8530
info@rose-plastic.us

CHINA

rose plastic (Kunshan) Co., Ltd.

Donghui Road No. 101, Zhoushi Town,
Kunshan, Jiangsu Province
Tel. +86 512 5766 7700
info@rose-plastic.cn

BRAZIL

rose plastic Brasil Embalagens Plásticas Ltda.

Av. Garabed Gananim 514, Jardim Topázio
CEP 18087-340 Sorocaba SP
Tel. +55 15 3238 1900
info@rose-plastic.com.br

INDIA

rose plastic India Pvt. Ltd.

Pargaon, Khandala, Satara - 412802
Maharashtra - India
Tel. +91 21 6929 9151
info@rose-plastic.in

Subsidiaries

UNITED KINGDOM

rose plastic UK Ltd.

Unit 4, Bessemer Way, Bessemer
Business Park, Rotherham, S60 1EN
Tel. +44 1709 7217 94
info@rose-plastic.co.uk

FRANCE

rose plastic France S.A.R.L.

Parc d'Activités du Rotey
73460 Notre Dame des Millières
Tel. +33 479 3848 01
info@rose-plastic.fr

SPAIN

rose plastic Iberia, S.L.U.

P.A.E. Ibarbarri, Pab. 15B
48940 Leioa (Vizcaya)
Tel. + 34 94 480 66 61
info@rose-plastic.es

REPUBLIC OF KOREA

rose plastic Korea Co., Ltd.

Bucheon Techno Park 402-B01, B02,
Pyung-Cheon Ro 655, Won-mi-gu,
Bucheon City, Gyung-gi-do, ROK 14502
Tel. +82 32 324-8332
info@rose-plastic.kr

ITALY

rose plastic Italia S.r.l.

Viale De Gasperi 103
20017 Rho (MI)
Tel. +39 02 9390 9450
info@rose-plastic.it

Sales partners

JAPAN

Honda Plus Co.Ltd.

23-2 Kawaji Yato
Shinshiro Pref. Aichi 441-13
Tel. +81 5362 31351
info.jp@rose-plastic.com

POLAND

Leniar International Sp. z o.o. Sp.K.

Ul.Szlak 67
31-153 Kraków
Tel. +48 12 6331 670
info.pl@rose-plastic.com

TURKEY

Tureks Endüstriyel Ürünler Pazarlama Ve Dış Ticaret A.Ş.

1471 Sokak No. 7 K:5 D:13
Kenet Sitesi
35220 Alsancak - Izmir
Tel. +90 232 464 5220
info.tr@rose-plastic.com



03/2025

USA

rose plastic USA, L.L.L.P.

P.O. Box 698

California, PA 15419-0698

Tel. +1 724 938 8530

info@rose-plastic.us

www.rose-plastic.us

rose  plastic®
protective packaging pioneers